



Bobath tables



REHABILITATION and MEDICAL EQUIPMENT



We aim to offer rehabilitation equipment and assistive devices that are useful to large institutions, smaller professional clinics and to end-users and their relatives at home. Our goal is to encourage people with reduced mobility to explore the limits of their individual abilities. We want to motivate our customers to improve everyday life conditions, creating a stronger desire to be more integrated with others.

Chinesport thanks all those who contribute to the development of the contents of this document.

Therapy tables		1
Electro-medical equipment	2	
Rehabilitation	3	
Pulley therapy	4	
Occupational therapy	5	
Standing frames	6	
Tilt tables	7	
Parallel bars and exercise staircases	8	
Walkers	9	
Treadmills	10	
Tractions	11	
Medical gymnastics	12	
Hydrotherapy	13	
Posture analysis	14	
Hoisting and transfer	15	
Hygiene systems	16	
Lifting armchairs	17	
Patient transport	18	

At our sole discretion, the company reserves the right to change dimensions and type of construction, and to make improvements and other changes to its products. All reproduction rights of all or part of the designs and illustrations are reserved worldwide. The printing process can't give a perfect reproduction of the colours.



Bobath tables

1. Height adjustable models	page 02
1.1 Introduction	page 02
1.2 Configuration Guide	page 03
1.2.1 The padded sections	page 04
1.2.2 Height adjustment	page 06
1.2.3 Other options	page 08
1.2.4 Edges finishing and heating system	page 09
1.2.5 Upholstery colours	page 10
2. Accessories	page 12
2.1 Cushions for posture	page 12
2.2 General accessories	page 16
2.2 Specific accessories	page 17
3. The configurable models	page 18
4. Fixed height models	page 24
Appendix	page 26
I - Stools	page 26
II - Overview on the range	page 28



PATENTED
MODELLO
COMUNITARIO
DEPOSITATO



ADJUSTMENT OF THE PADDED SECTIONS

All the padded sections of our therapy tables are adjustable by an ergonomic hand control which activates one or more gas springs or an electrically motorized system. This control with a shape of a handle is an original Chinesport design element originated as a result of our constant wish to care about details.

The adjustment of the sections by a gas spring is more continuous, constant and silent and can be carried out without any effort by the operator. This is a quality choice which has turned out very reliable in time.



Large physical therapy tables are suitable for neurological treatments, as patients can be guided through a wide range of exercises and sensory experiences, as well as postural adjustments. The surface area can measure up to four square meters.

We have developed a wide range of big size tables after 40 years of experience. We have offered a wide variety of project solutions to cope with specific needs for institutions and professional requirements. In general, the Bobath tables have different sizes and can offer different performances. They have padded sections which can be adjusted manually by means of a gas spring or by an electrical actuator. Height adjustment can be both electrical and hydraulic according to the model. Different control systems are available accordingly.

The table can be set with casters and centralized brake system, as well as with side safety bands, which can be used when necessary. Colour can be chosen among the 24 choices available and it is possible to set the warming of the padded sections.



Product customization

It is also worth remembering that our Research & Development department is continually developing new options and accessories to achieve table configurations that increasingly meet the professionals' individual requirements.

At the same time feel free to send your specific enquiry for product customization. Write to export@chinesport.it

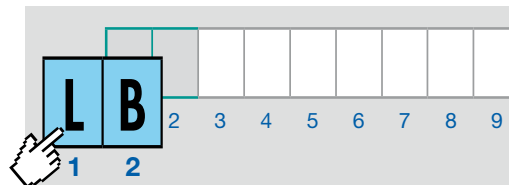

PRODUCT CODE MEANING

The product code for Chinesport height-adjustable treatment tables is an "open code" that varies depending on the choice of various options available for each model. Each code position has a particular meaning, which corresponds with one or more features of the table.

CODE POSITIONS 3-4-5

The padded sections

These first positions of the code identify the different models according to the size and number of padded sections as well as according to the possible adjustments which can be done. Furthermore, the maximum load is considered. It can be up to 150 kg or up to 250 kg.

POSITION CODE 6

Height adjustment

- A** - Electric, with foot switch
- B** - Electric, all-around operation
- C** - Hydraulic, with pedal
- D** - Electric, with hand control
- F** - Electric with hand control (for versions with two motors only)
- G** - Electric, footswitch with its holder

CODE POSITION 7

Other options

- 1** - No further options
- 2** - Wheels for transferring
- 3** - Safety siderails
- 4** - Wheels and safety siderails

CODE POSITION 8

Edges finishing / Heating system

- W** - Seamless rounded edges
- X** - Squared edges
- Z** - Heating system

CODE POSITION 9

Upholstery Colours

Giotto collection
Standard range of 24 colours.

Bobath Line Configuration Guide

POSITIONS 3-4-5

The padded sections

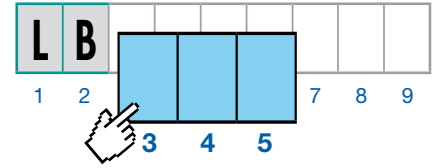

  **3 1 1 BOBATH ECO D100**
Electric version
SWL Max kg 150





  **4 1 1 BOBATH SD100**
Electric version
SWL Max kg 250





  **4 1 2 BOBATH SD120**
Electric version
SWL Max kg 250



  **Hydraulic version**
SWL Max kg 150



  **4 1 3 BOBATH SD150**
Electric version
SWL Max kg 250

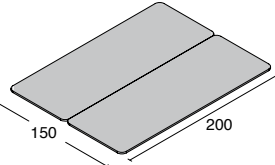



  **4 1 4 BOBATH SD200**
Electric version
SWL Max kg 250







  **3 2 1 BOBATH ECO T100**
Electric version
SWL Max kg 150



  **4 2 1 BOBATH ST100**
Electric version
SWL Max kg 250



  **4 2 2 BOBATH ST120**
Electric version
SWL Max kg 250

  **Hydraulic version**
SWL Max kg 150

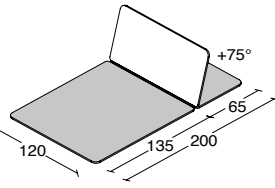



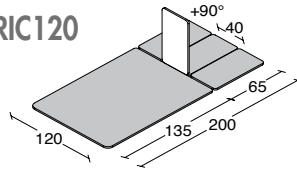

4 3 2 BOBATH S RIC120
Electric version
SWL Max kg 250

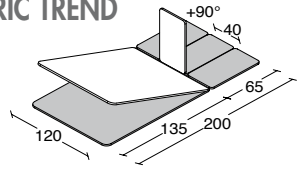

4 7 2 BOBATH S RIC TREND
Electric version
SWL Max kg 250

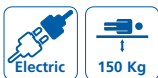
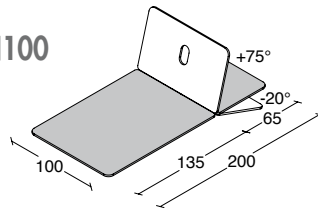

3 4 1 BOBATH TN100
Electric version
SWL Max kg 150



3 5 1 BOBATH FLEX 100
Electric version
SWL Max kg 150

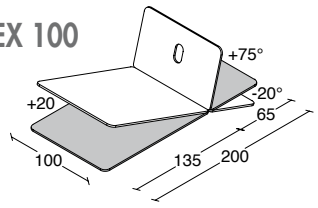

3 6 1 BOBATH TREND 100
Electric version
SWL Max kg 150

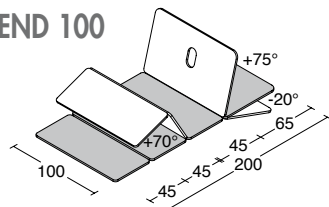

4 9 2 BOBATH TILT TABLE 2ET
Electric version
SWL Max kg 250
SWL Max kg 190

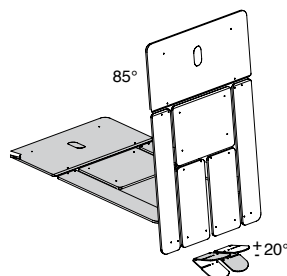
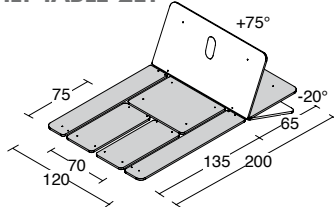

Bobath Line Configuration Guide

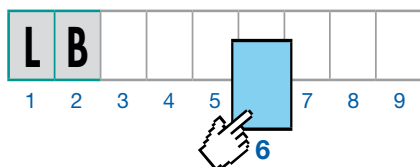

POSITION 6

Height adjustment

Chinesport tables of the Bobath series can have an electrical or hydraulic height adjustment from a minimum of 47 cm to a maximum of 97 cm. Electrical adjustment can be performed by different ways. Standard electrical supply is 220 V 50 – 60 Hz and all controls work at low tension regime. Clients can request a power supply of 110 V 50 – 60 Hz and not a SHUKO plug. The minimum level of protection of the electrical parts is IP 54.



A **Electric, with foot switch**
This type of control represents a basic option. The foot switch is placed on the floor. The connection cable allows for complete freedom of movement.



B **Electric, all around operation**
This is an electric height adjustment system that can be reached from anywhere around the table, without having to locate the foot switch. It is activated by simply pressing or lifting the perimeter bar.



C **Hydraulic, with pedal**
This hydraulic adjustment is ideal for situations where there is no power supply or when you need to move the table easily.



PATENTED

The adjustable structure in height of our Bobath tables, with two half-moon levers as a main feature is an original Chinesport design protected in Europe as “EU model”.



D Electric, with hand control
Ergonomic hand control with magnet. Can be attached wherever wished on the table frame. It comes with connection cable.



F Electric, two motors with hand control
This option has an ergonomic hand control with magnet that users can attach wherever they wish on the table frame. This is for models that have two electric actuators, one for table height adjustment and one for padded sections.



G Electric, with foot switch on its base
The control is securely placed in a special holder, which has to be attached at the base of the structure. The pedal control on its holder makes the transferring of the table easier, as well as, eventually the cleaning operations near it.



HOW TO ORDER A CHINESPORT THERAPY TABLE



The video aims to facilitate the reading of the various options presented in the catalog page for different models of our therapy tables. In particular, we show how the same page can be used to express a choice of the configuration of the product during the purchase.

Bobath Line Configuration Guide

POSITION 7

Other options

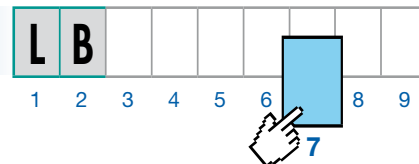

Various additional options are available to configure our Bobath tables after having chosen the height adjustment system and the type of drive. At the moment, we can add wheels to move the table easily, and safety siderails or armrests to provide greater comfort for the patient. These options can also be combined.



1 No options
When inserting the product configuration code, please specify if you are interested in any of the options available for position 7 of the code.

3 Safety siderails
Siderails offer greater safety to patients while they are lying on the table, or when the professional needs to step away temporarily. They can be fitted as and when needed thanks to an easy manual mechanism.



2 With wheels for transportation
Swiveling, non-marking wheels with a central braking system activated via a single foot pedal. Moving the table is extremely comfortable and requires no effort. The table cannot be moved when a patient is lying on the table.



4 With wheels and safety siderails
Please indicate if you would like the table to be fitted with wheels and safety siderails, for greater patient safety. The wheels braking system is controlled by a single foot pedal.

POSITION 8

Edges finishing and Heating system

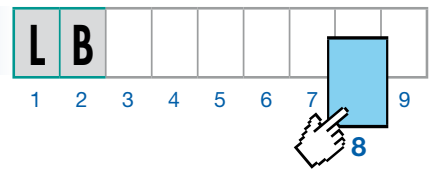

The different models of the Bobath series can have a different type of upholstery. The different parts that make up the table can have seamless edges or they may have a side band. Both possibilities are identified by code 8 when configuring the product.



FOR HIGHER COMFORT AND BENEFITS AS A RESULT OF WARMING

Benefits of heat as a physical therapy are well known and they include reduction of pain, muscle relaxation and the improvement of wellbeing of the patient. Other benefits are improvement of blood circulation and soft tissue extensibility. Therefore, it is possible to add a warming feature to the padded sections of our Bobath tables. A specific control can allow the setting of two different levels of temperature.

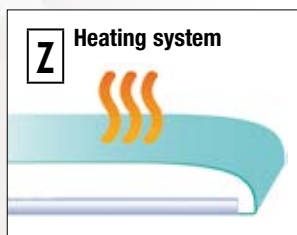

This icon, in the product features, indicates that the therapy tables can have warming functions. Please make clear in your order to be interested in having this feature.

PADDING DENSITY AND DEPTH

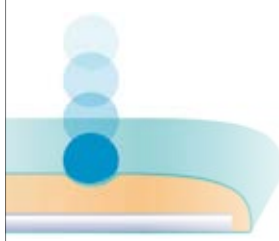

Chinesport normally uses a padding depth and density that is 40mm and 30kg/m³. However, our Upholstery Department is able to deal with particular non-standard requests. In such cases, an additional charge may be applied.

PANEL STABILITY

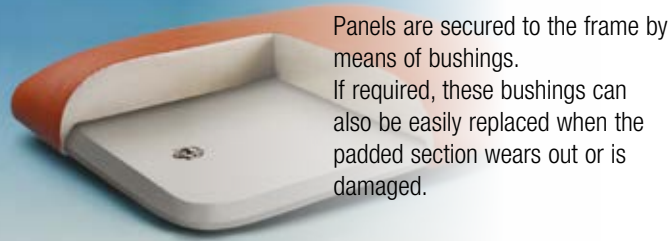

Panels are secured to the frame by means of bushings. If required, these bushings can also be easily replaced when the padded section wears out or is damaged.

Bobath Line Configuration Guide

POSITION 9



Upholstery colours



COMFORT AND FLEXIBILITY



TEAR-RESISTANT



WATERPROOF



EASY MAINTENANCE



FIRE-RESISTANT



RESISTANT TO UV RADIATIONS



FUNGICIDAL TREATMENT



GiottoCollection Standard Range

Giotto is a coated fire-resistant fabric. It is sturdy and easy to care, making it particularly suitable for use in hospitals, care homes, spas, rehabilitation centers and gyms. Giotto has a leather effect surface and shiny finish, and comes in a wide array of colors. Giotto contains Vinyzene, an anti-microbial that is added during the processing stages to create a protective barrier against dust mites, bacteria and fungi, preventing any bad odors and allergies.

WA WHITE	WN IVORY	W8 BEIGE	W7 ASHGREY	WK GREY	WS DARK BROWN
WB CREAM	W4 YELLOW	WT GREEN LEMON	W1 DARK GREEN	W6 LIGHT GREEN	WE AQUAMARINE
WZ ORANGE	WG CORAL	WF RED	WH BURGUNDY	W9 FUCHSIA	WQ LILAC
WR LIGHT CORNFLOWER BLUE	W2 LIGHT BLUE	W3 MARINE BLUE	WL DARK BLUE	WM ANTHRACITE	WP BLACK

When ordering remember to state the colour code for the upholstery. Available on a standard range of 24 colours.



Accessories Cushions for posture

Postural cushions are available in various shapes and sizes to meet the professional's varied requirements to position a patient correctly. Our cushions are made from variable density foam and have a synthetic leather cover which is fire-resistant and anti-bacterial, easy to clean and durable. Standard density is 21 kg/m³. Cushion covers have a zip for easy removal, and come in a choice of upholstery from an assortment of 24 color options. Cushions can be purchased in the same type of upholstery as the examination or therapy table.

KEY: W = width; D = depth; H = height; all dimensions are in centimeters (cm).

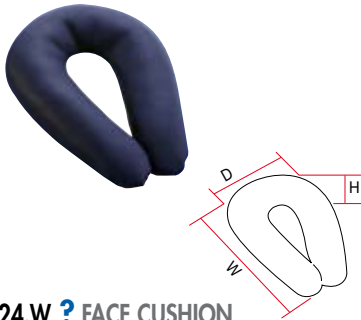

AC0024.W ? FACE CUSHION
W 31 x D 23 x H 6

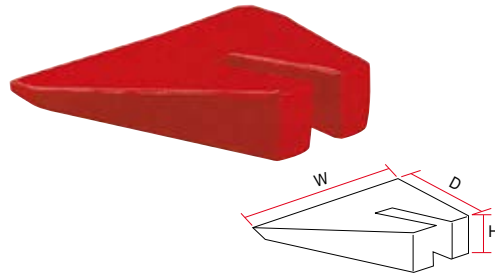

AC0025.W ? CUSHION WITH HOLE
W 40 x D 34 x H 9

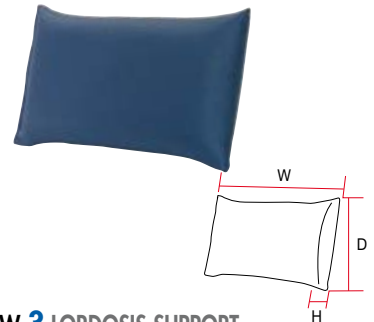

10321.W ? LORDOSIS SUPPORT
W 29 x D 14 x H 5

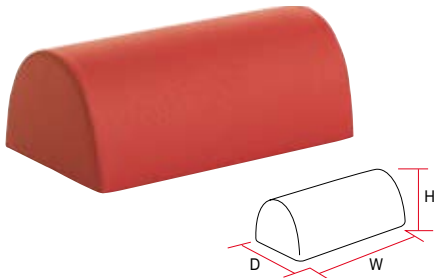

10300.W ? SEMI-CYLINDER 1 - W 48 x D 25 x H 18
10310.W ? SEMI-CYLINDER 2 - W 60 x D 40 x H 18

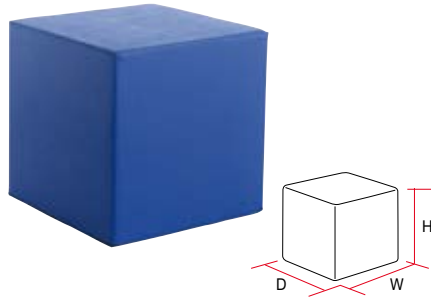

09940.W ? CUBE 1 W 40 x D 40 x H 40
09950.W ? CUBE 2 W 50 x D 50 x H 50

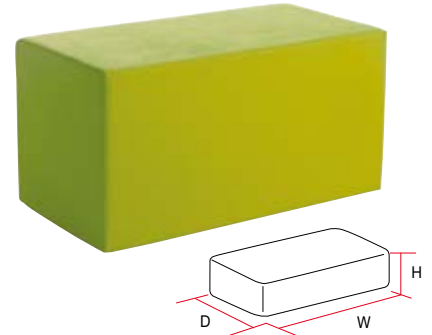

09700.W ? RECTANGLE 1 - W 40 x D 20 x H 10
09730.W ? RECTANGLE 2 - W 40 x D 30 x H 5
09740.W ? RECTANGLE 3 - W 40 x D 30 x H 10
09820.W ? RECTANGLE 4 - W 80 x D 40 x H 40

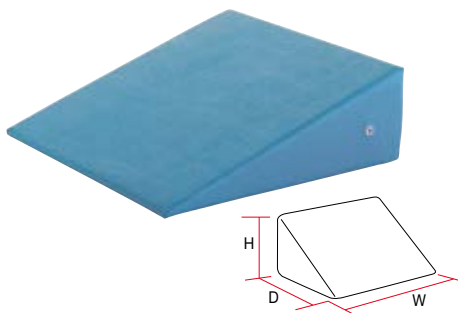

09600.W ? WEDGE 1 - W 25 x D 25 x H 10
09610.W ? WEDGE 2 - W 35 x D 35 x H 10
09620.W ? WEDGE 3 - W 60 x D 45 x H 15
09630.W ? WEDGE 4 - W 60 x D 45 x H 30
09640.W ? WEDGE 5 - W 60 x D 60 x H 15
09650.W ? WEDGE 6 - W 60 x D 60 x H 20

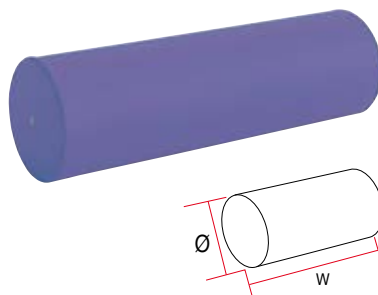

10000.W ? CYLINDER 1 - W 20 x Ø 8
10010.W ? CYLINDER 2 - W 35 x Ø 15
10020.W ? CYLINDER 3 - W 50 x Ø 15
10030.W ? CYLINDER 4 - W 50 x Ø 25
10050.W ? CYLINDER 5 - W 100 x Ø 25

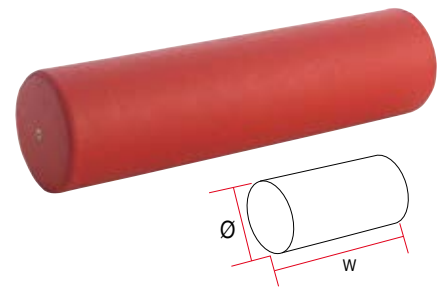

10130.W ? RIGID ROLL 1 - W 100 x Ø 30
10150.W ? RIGID ROLL 2 - W 100 x Ø 40
10160.W ? RIGID ROLL 3 - W 100 x Ø 50
10200.W ? RIGID ROLL 4 - W 50 x Ø 30

? CHOICE OF UPHOLSTERY COLOR - important: always specify the upholstery code along with the chosen item when this option is available



BOBATH LINE

THE PADDED SECTIONS

Our Bobath therapy tables can have sections of different width, i. e., width can be 100, 120, 150 and up to 200 centimetres, while the standard length is always the same i.e. 200 cm.

The padded sections can be adjusted by one or more gas springs or by a second motorized unit. Especially the head section can be adjusted only in positive, or in positive and negative according to the model.

The chest-legs section can be set to the "Trendelenburg position", or to a "relaxing position" with bent legs, without any tension at the psoas muscle level.



Accessories Cushions for posture

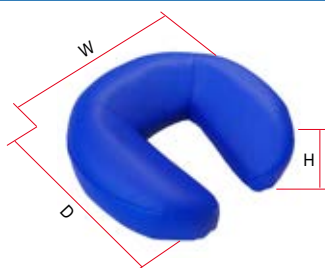

AC0881.W ? FACE CUSHION 2
A cushion with a special shape and density which makes comfortable the prone position of the patient during treatment and therapies. This cushion is advisable for offering great relaxation to patients. Dimensions: W 29 x D 31 x H 9 cm.



AC0966.W ? NECK SUPPORT S
Shaped cushion for use in supine position. Dimensions: W 27 x D 24 x H 9 cm.

AC0967.W ? NECK SUPPORT L
Dimensions: W 27 x D 48 x H 9 cm.

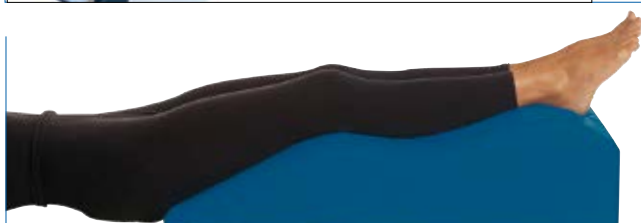

11250.W ? LEG CUSHION
L 77 x D 50 x H 20/15

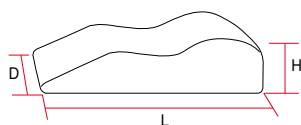

KEY: W = width; D = depth; H = height; all dimensions are in centimeters (cm).

MADE-TO-MEASURE CUSHIONS

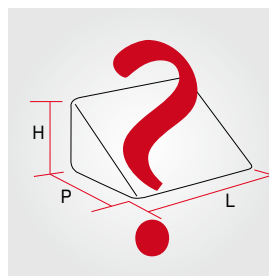

On request, we can manufacture cushions with non-standard size and density. Feel free to send us your request by e-mail to our address: export@chinesport.it

? CHOICE OF UPHOLSTERY COLOR - important: always specify the upholstery code along with the chosen item when this option is available





RETURN TO THE ORIGINAL SHAPE

Cushions come in various sizes, they are elastic and mould easily but always return to their original shape. They offer an ideal support to the lumbar and lateral region, as well as to the upper and lower limbs. They are covered in a washable, breathable fabric.



- 01449 POSTURAL CUSHION 100 - ø cm 19 x 17
- 01450 POSTURAL CUSHION 110 - ø cm 19 x 31
- 01451 POSTURAL CUSHION 120 - ø cm 25 x 37
- 01452 POSTURAL CUSHION 8 - cm 40 x 20 x 13 H
- 01453 POSTURAL CUSHION 88 - cm 50 x 28 x 13 H

01426 POSTURAL SET
This set includes 5 cushions, one for each type specified above, and a carry bag to store the items, size 33 x 33 x 56 h cm.



GENERAL ACCESSORIES



AC0037 ADDITIONAL FOOT PEDAL 1

For models fitted with a single motor. The additional foot pedal provides another way to control the table height adjustment. It can be used on both sides.



AC0038 ADDITIONAL FOOT PEDAL 2

For models fitted with two motors. The additional foot pedal provides another way to control the table height adjustment, as well as the motorized sections. This accessory can be used on both sides.



AC0039 ADDITIONAL HAND CONTROL 1

For models fitted with a single motor. The additional hand control provides another way to control the table height adjustment. This hand control has a magnet so it can be easily attached to the table frame, without any restrictions on the location.



AC0040 ADDITIONAL HAND CONTROL 2

For models fitted with two motors. The additional hand control provides another way to control the table height adjustment, as well as to adjust the motorized sections. This hand control has a magnet so it can be easily attached to the table frame, without any restrictions on the location.



AC0997 FOOT SWITCH HOLDER

Can be applied on either side of the base frame as preferred by the carer, and enables the accessory AC0083 to be fitted. Not compatible for therapy tables with perimeter footswitch (option B).



AC0083 ADDITIONAL CONTROL

It can be used both as a foot pedal in combination with the corresponding holder, code AC0997, or as a hand control. It has a magnet that enables it to be attached anywhere on the frame.



AC0578 SAFETY DEVICE

This device disconnects the mains supply from the height adjustment system. This stops any inappropriate use when the carer is away. The device consists of a manual switch.



AC0035 MAXI PAPER ROLL SET

The set includes 2 x 90 cm wide rolls. Each roll is 100 meters long.



SPECIFIC ACCESSORIES FOR BOBATH TILT MODEL



AC0005 BASIC STRAP

Provides better restraint for the patient; can be fitted at the desired height by means of special guides. (single piece)



AC0006 STRAP PADDING

Padded cushion offering greater and more comfortable support to the patient. To be used in combination with strap code AC0005. (single piece)



AC0003 SHAPED SUPPORTS 2

These supports are made of black soft material and they have chromed parts which allow width adjustment. The supports can also be then adjusted in depth and height. (2 pieces)

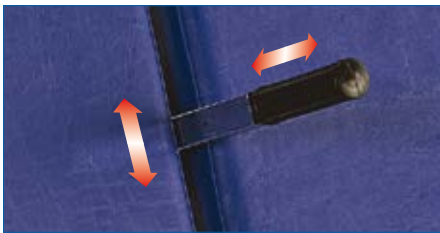

AC0004 HAND GRIPS 2

Side handles to allow the patients to grip and support themselves while exercising in a static supine position. They can be adjusted in height and depth. (2 pieces).



AC0912 GUIDE FOR LEGS STRAP

A specific hand grip can be fixed onto a central rail specially designed for this purpose, which is located between the legs section of the static table. This hand grip allows, therefore, to keep an eventual strap with code AC0005 – BASIC STRAP.



AC0911 ABDUCTION BLOCK

If need be, a padded wedge can be mounted on a central rail to keep the patient's legs apart. This device includes also a hand grip which can then be used to keep an eventual strap with code AC0005 – BASIC STRAP. The hand grip improves the restraining of the legs.



AC0002 INTRA - EXTRA SANDALS

Once fitted to the footplates, they restrain and stabilise the feet. Can be adjusted into intra-extra rotation and antero-posterior movement. (2 pieces)

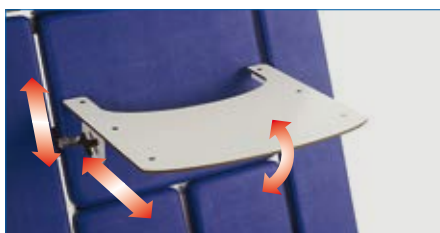

AC0308 SERVICE TRAY

It is shaped with rounded corners. The recess on one side makes it easier for the user to get closer to it. (single piece)



Fitting the footplate assembly for use with static exercises in supine position

Bobath Line *The models and their options*

Pos. 3 - 4 - 5 Type of sections

311 BOBATH ECO D100

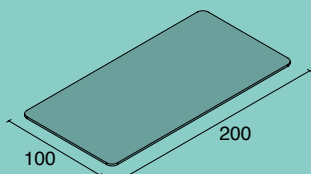

411 BOBATH SD100

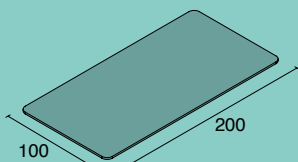

412 BOBATH SD120

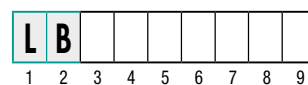
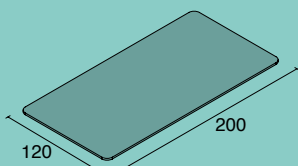

Model shown - code LB 412 A2 W3

Pos. 6 Height adjustment

For all models:

- A** Electric, with foot switch
- B** Electric, all-around operation
- D** Electric, with hand control
- G** Electric, with foot switch on its base

For model LB412 only:

- C** Hydraulic, with pedal



Accessible up to cm 18



Pos. 7 Other options

- 1** No options
- 2** With wheels for transportation
- 3** Safety siderails
- 4** Wheels and siderails

Pos. 8 Synthetic leather design

- W** Seamless rounded edges
- Z** Heating system

Pos. 9 Section upholstery color

24 options available

TECHNICAL FEATURES

Number of sections	1
Max safety load (kg) - LB311	Electric 150
Max safety load (kg) - LB411-LB412	Electric 250 / Hydraulic 150
Height adjustment	Electric / Hydraulic (LB412 only)
Minimum/maximum table height (cm)	47-97
Mains supply	220V 50-60Hz / 24V 70VA
Actuator thrust (N) - LB311	6000
Actuator thrust (N) - LB411-LB412	10000
IP Protection	54
Wheels diameter (mm)	65
Braking system	Central
Upholstery safety rating	1 IM
Padding thickness (mm)	40
Density (kg/m ³)	30
Weight (kg)	90 / 93 / 98



ACCESSORIES:

ELECTRICAL ACCESSORIES:

- AC0037 ADDITIONAL FOOT SWITCH 1
- AC0039 ADDITIONAL HAND CONTROL 1
- AC0083 ADDITIONAL CONTROL
- AC0575 FOOT SWITCH HOLDER
- AC0578 SAFETY DEVICE

FOR PROTECTION AND HYGIENE:

- AC0035 MAXI PAPER ROLL SET

CUSHIONS FOR POSTURE:

Refer to the first pages

upholstery
color code



Pos. 3 - 4 - 5 Type of sections

413 BOBATH SD150

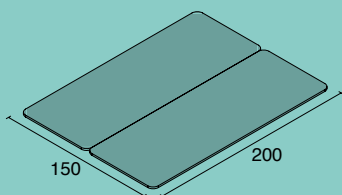

414 BOBATH SD200

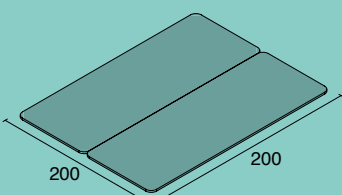

Pos. 6 Height adjustment

- A** Electric, with foot switch
- D** Electric, with hand control
- G** Electric, with dual control

Pos. 7 Other options

- 2** With wheels for transportation
- 4** Wheels and siderails

Pos. 8 Synthetic leather design

- W** Seamless rounded edges

Pos. 9 Section upholstery color

24 options available

Configuration example for a treatment table from the VISIT range.



For further information on options and accessories, please refer to the first pages.



Model shown - code LB 414 A2 W3



TECHNICAL FEATURES

Number of sections	2
Max safety load (kg)	250
Height adjustment	Electric
Minimum/maximum table height (cm)	47-97
Mains supply	220V 50-60Hz / 24V 70VA
Actuator thrust (N)	10000
IP Protection	54
Wheels diameter (mm)	65
Braking system	Central
Upholstery safety rating	1 IM
Padding thickness (mm)	40
Density (kg/m ³)	30
Weight (kg)	140 / 156



ACCESSORIES:

ELECTRICAL ACCESSORIES:

- AC0037 ADDITIONAL FOOT SWITCH 1
- AC0039 ADDITIONAL HAND CONTROL 1
- AC0083 ADDITIONAL CONTROL
- AC0578 SAFETY DEVICE

FOR PROTECTION AND HYGIENE:

- AC0035 MAXI PAPER ROLL SET

CUSHIONS FOR POSTURE:

Refer to the first pages

upholstery color code



Bobath Line *The models and their options*

Pos. 3 - 4 - 5 Type of sections

321 BOBATH ECO T100

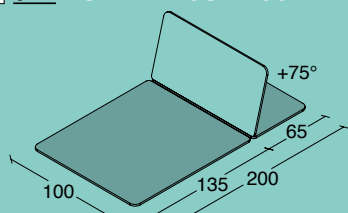

421 BOBATH S T100

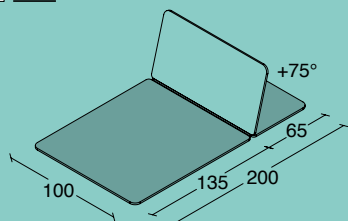

422 BOBATH S T120

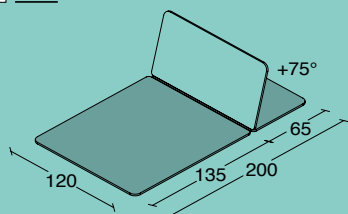

Pos. 6 Height adjustment

For all models:

- A** Electric, with foot switch
- B** Electric, all-around operation
- D** Electric, with hand control
- G** Electric, with dual control

For model LB422:

- C** Hydraulic

Pos. 7 Other options

- 1** No options
- 2** With wheels for transportation
- 3** Safety siderails
- 4** Wheels and siderails

Pos. 8 Synthetic leather design

- W** Seamless rounded edges
- Z** Heating system

Pos. 9 Section upholstery color

24 options available

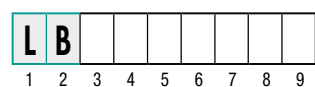

Model shown - code LB 422 A1 W3



TECHNICAL FEATURES

Number of sections	2
Max safety load (kg) - LB321	Electric 150
Max safety load (kg) - LB421-LB422	Electric 250 / Hydraulic 150
Height adjustment	Electric / Hydraulic (LB422 only)
Minimum/maximum table height (cm)	47-97
Mains supply	220V 50-60Hz / 24V 70VA
Actuator thrust (N) - LB321	6000
Actuator thrust (N) - LB421-LB422	10000
IP Protection	54
Head section adjustment	Gas spring-assisted
Head section tilt	75°
Wheels diameter (mm)	65
Braking system	Central
Upholstery safety rating	1 IM
Padding thickness (mm)	40
Density (kg/m³)	30
Weight (kg)	90 / 93 / 103



ACCESSORIES:

ELECTRICAL ACCESSORIES:

- AC0037 ADDITIONAL FOOT SWITCH 1
- AC0039 ADDITIONAL HAND CONTROL 1
- AC0083 ADDITIONAL CONTROL
- AC0575 FOOT SWITCH HOLDER
- AC0578 SAFETY DEVICE

FOR PROTECTION AND HYGIENE:

- AC0035 MAXI PAPER ROLL SET

CUSHIONS FOR POSTURE:

Refer to the first pages

upholstery
color code



Pos. 3 - 4 - 5 Type of sections

432 BOBATH S RIC 120

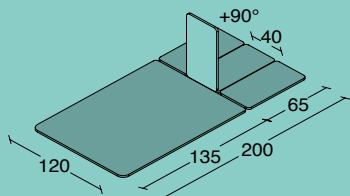

472 BOBATH S RIC TREND 120

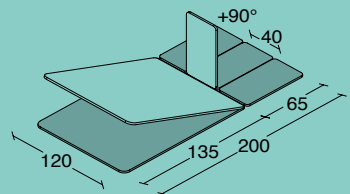

Pos. 6 Height adjustment

B Electric, all-around operation

For model LB432 only:

D Electric, with hand control

For model LB472 only:

F Electric, two motors with hand control

Pos. 7 Other options

1 No options

2 With wheels for transportation

3 Safety siderails

4 Wheels and siderails

Pos. 8 Synthetic leather design

W Seamless rounded edges

For model LB432 only:

Z Heating system

Pos. 9 Section upholstery color

24 options available

Configuration example for a treatment table from the VISIT range.

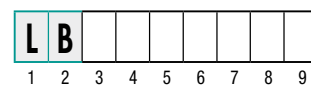

Model shown - code LB 432 A2 W3



TECHNICAL FEATURES

Number of sections	4
Max safety load (kg)	250
Height adjustment	Electric
Minimum/maximum table height (cm)	47-97
Mains supply	220V 50-60Hz / 24V 70VA
Actuator thrust (N)	10000
IP Protection	54
Head section adjustment	Gas spring-assisted
Head section tilt	90°
Wheels diameter (mm)	65
Braking system	Central
Upholstery safety rating	1 IM
Padding thickness (mm)	40
Density (kg/m³)	30
Weight (kg)	98 / 108



ACCESSORIES:

ELECTRICAL ACCESSORIES:

- AC0037 ADDITIONAL FOOT SWITCH 1
- AC0038 ADDITIONAL FOOT PEDAL 2 *
- AC0039 ADDITIONAL HAND CONTROL 1
- AC0040 ADDITIONAL HAND CONTROL 2 *
- AC0083 ADDITIONAL CONTROL
- AC0575 FOOT SWITCH HOLDER
- AC0578 SAFETY DEVICE

FOR PROTECTION AND HYGIENE:

- AC0035 MAXI PAPER ROLL SET

CUSHIONS FOR POSTURE:

Refer to the first pages

* IMPORTANT NOTE: accessories AC0038 and AC0040 are only available for model LB 472

upholstery color code



Bobath Line *The models and their options*

Pos. 3 - 4 - 5 Type of sections

341 BOBATH TN100

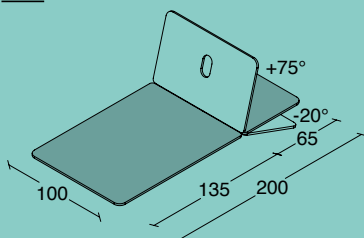

351 BOBATH FLEX 100

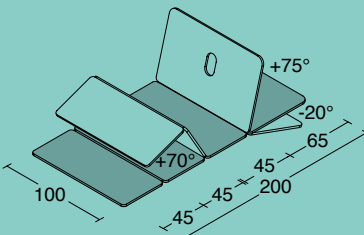

361 BOBATH TREND 100

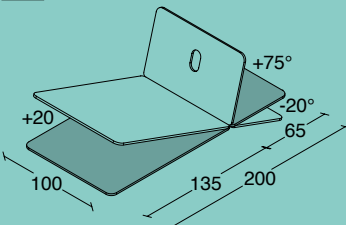

Pos. 6 Height adjustment

For model LB341:

- A** Electric, with foot switch
- B** Electric, all-around operation
- D** Electric, with hand control
- G** Electric, with dual control

For models LB351, LB361:

- F** Electric, two motors with hand control

Pos. 7 Other options

- 1** No options
- 2** With wheels for transportation

Pos. 8 Synthetic leather design

- W** Seamless rounded edges

For models LB341 and LB361:

- Z** Heating system

Pos. 9 Section upholstery color

24 options available

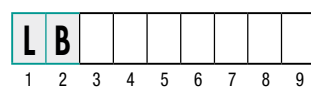

Model shown - code LB 351 F2 W3

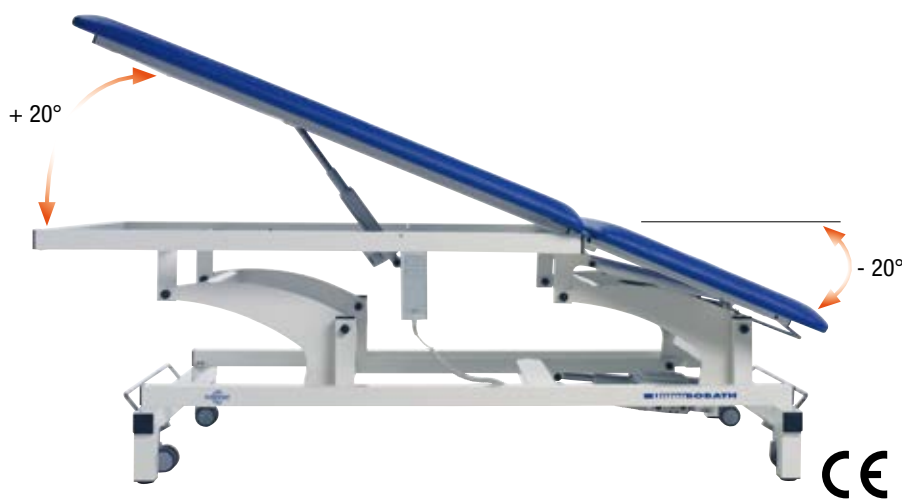

TECHNICAL FEATURES

Number of sections	2 / 4
Max safety load (kg)	150
Height adjustment	Electric
Minimum/maximum table height (cm)	47-97
Mains supply	220V 50-60Hz / 24V 70VA
Actuator thrust (N)	6000
IP Protection	54
Head section adjustment	Gas spring-assisted
Head section tilt	-20° +75°
Wheels diameter (mm)	65
braking system	Central
Upholstery safety rating	1 IM
Padding thickness (mm)	40
Density (kg/m)	30
Weight (kg)	85 / 93 / 93

ACCESSORIES:

ELECTRICAL ACCESSORIES:

- AC0037 ADDITIONAL FOOT SWITCH 1
- AC0038 ADDITIONAL FOOT PEDAL 2
- AC0039 ADDITIONAL HAND CONTROL 1
- AC0040 ADDITIONAL HAND CONTROL 2
- AC0575 FOOT SWITCH HOLDER *
- AC0578 SAFETY DEVICE

FOR PROTECTION AND HYGIENE:

- AC0035 MAXI PAPER ROLL SET

CUSHIONS FOR POSTURE:

Refer to the first pages

* Foot switch holder not compatible if perimeter footswitch (option B) is chosen

upholstery color code



Pos. 3 - 4 - 5 Type of sections

492 BOBATH S TILT TABLE 2ET

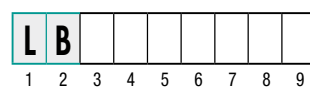
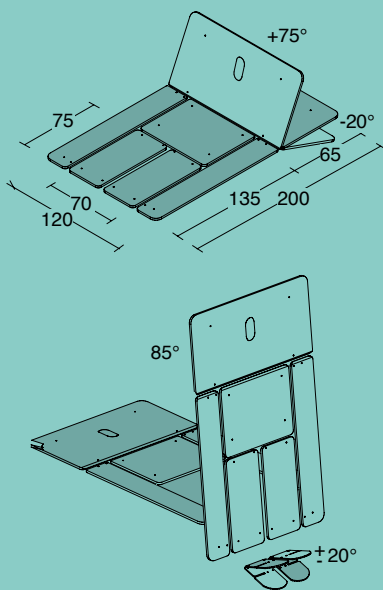

Model shown - code LB 492 F2 X3

Pos. 6 Height adjustment

F Electric, two motors with hand control

Pos. 7 Other options

2 With wheels for transportation

Pos. 8 Synthetic leather design

X Squared edges

Pos. 9 Section upholstery color

24 options available



TECHNICAL FEATURES

Number of sections	6
Max safety load (kg)	250 hoisting / 190 tilt table
Height adjustment	Electric
Minimum/maximum table height (cm)	55-105
Mains supply	220V 50-60Hz / 24V 70VA
Actuator thrust (N)	10000
IP Protection	54
Head section adjustment	Gas spring-assisted
Head section tilt	-20° +75°
Wheels diameter (mm)	65
braking system	Central
Upholstery safety rating	1 IM
Padding thickness (mm)	40
Density (kg/m³)	30
Weight (kg)	170

ACCESSORIES:

ELECTRICAL ACCESSORIES:

- AC0083 ADDITIONAL CONTROL
- AC0575 FOOT SWITCH HOLDER
- AC0578 SAFETY DEVICE

FOR PROTECTION AND HYGIENE:

- AC0035 MAXI PAPER ROLL SET

PADDED SUPPORTS AND ELEMENTS:

- AC0002 INTRA-EXTRA SANDALS
- AC0003 TRUNK SUPPORTS
- AC0004 FOREARM SUPPORTS
- AC0005 FASTENING STRAP
- AC0006 STRAP CUSHION
- AC0308 BOBATH TILT TABLE
- AC0311 LEG SPREADER
- AC0312 STRAP GUIDE

CUSHIONS FOR POSTURE:

Refer to the first pages



Removable footplate assembly

upholstery color code



Bobath tables Fixed height models



01263.W ?

RAMIN H100

Wooden examination and treatment table with one single section and fixed height at 78 cm. Larger dimensions for a total surface area that is 100 x 200 cm. Max safety load: 250 kg; Weight: 58 kg

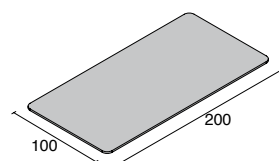

01264.W ?

RAMIN HT100

Wooden examination and treatment table with two sections and fixed height at 78 cm. Larger dimensions for a total surface area that is 100 x 200 cm. The head section can have manual positive tilt adjustment up to +55°. Max safety load: 250 kg; Weight: 60 kg

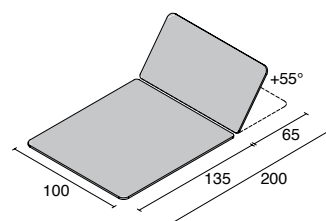

01261.W ?

RAMIN L100

Wooden examination and treatment table with one single section and fixed height 50 cm. Larger dimensions for a total surface area that is 100 x 200 cm. Max safety load: 250 kg; Weight: 53 kg

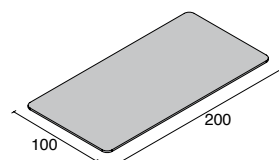

01262.W ?

RAMIN LT100

Wooden examination and treatment table with two sections and fixed height at 50 cm. Larger dimensions for a total surface area that is 100 x 200 cm. The head section can have manual positive tilt adjustment up to +55°. Max safety load: 250 kg; Weight: 55 kg

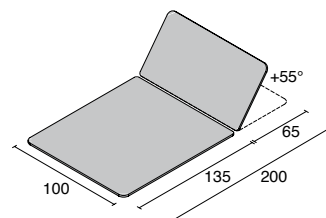

Please refer to the introduction page of this section for further details on our accessories.

? CHOICE OF UPHOLSTERY COLOR - important: always specify the upholstery code along with the chosen item when this option is available.





01256.W ?

METAL H100

An examination and treatment table with one single section and fixed height at 78 cm. Larger dimensions for a total surface area that is 100 x 200 cm.

Max safety load: 250 kg; Weight: 58 kg

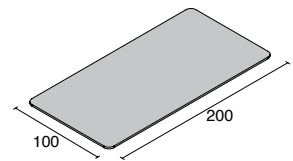

01257.W ?

METAL HT100

An examination and treatment table with two sections and fixed height at 78 cm. Larger dimensions for a total surface area that is 100 x 200 cm. The head section can have manual positive tilt adjustment up to +55°.

Max safety load: 250 kg;

Weight: 60 kg

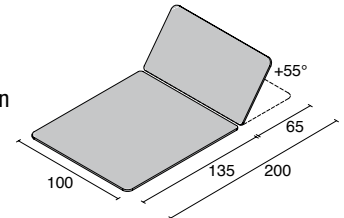

01253.W ?

METAL L100

An examination and treatment table with one single section and fixed height at 50 cm. Larger dimensions for a total surface area that is 100 x 200 cm.

Max safety load: 250 kg;

Weight: 53 kg

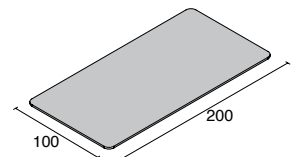

01254.W ?

METAL LT100

An examination and treatment table with two sections and fixed height at 50 cm. Larger dimensions for a total surface area that is 100 x 200 cm. The head section can have manual positive tilt adjustment up to +55°.

Max safety load: 250 kg; Weight: 55 kg

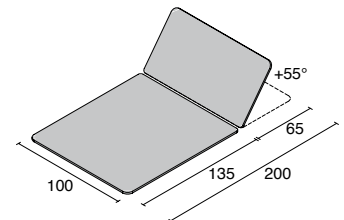

01423.W ?

METAL L200

Metal examination and treatment table with two connected sections, for a total surface area that is 200 x 200 cm.

Fixed table height at 50 cm.

Max safety load: 250 kg;

Weight: 106 kg

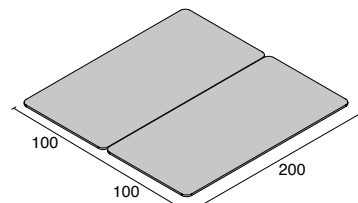

Please refer to the introduction page of this section for further details on our accessories.

? CHOICE OF UPHOLSTERY COLOR - important: always specify the upholstery code along with the chosen item when this option is available.



Appendix I Stools

CUSTOM STOOLS

Series of swivel stools with five swivel wheels and 60 cm diameter base. Height is adjusted by means of a gas spring mechanism and lever. Models come with two different height adjustment mechanisms.

Our stools are manufactured using materials that ensure excellent seat stability over time. Bushings are also used to attach the seat to the frame, which allows for parts to be easily replaced when worn out or if the padding gets damaged, or even if you just want a new upholstery color. A wide choice of upholstery colors is available. 3-year guarantee.

C	S								
1	2	3	4	5	6	7	8	9	

Pos. 4 Synthetic leather design



1 Seamless rounded edges



2 Squared edges

Pos. 5 Backrest



1 Without backrest



2 With backrest

Pos. 6 Height adjustment



L From 46 to 60 cm



H From 60 to 90 cm

Pos. 7 Type of frame



1 Black plastic



2 Chromed



MADE-TO-MEASURE SEAT

We can personalize the seat height, density and shape. Feel free to send us your request by e-mail to our address: export@chinesport.it

Pos. 3 Basic model

- 1 Miguel
- 2 Ines
- 3 Saddle stool
- 4 Ronaldo

Pos. 4 Synthetic leather design

- 1 Seamless rounded edges
- 2 Squared edges

Pos. 5 Backrest

- 1 Without backrest
- 2 With backrest

Pos. 6 Height adjustment

- L from 46 ÷ 60 cm
- H from 60 ÷ 90 cm

Pos. 7 Type of frame

- 1 Black plastic
- 2 Chromed

Pos. 8 Type of synthetic leather

- W Giotto Collection

Pos. 9 Upholstery color

24 options available



Model shown - code CS1 12L2 WE

MIGUEL

C	S	1						W
1	2	3	4	5	6	7	8	9



Model shown - code CS2 21H1 W3

INES

C	S	2	2					W
1	2	3	4	5	6	7	8	9



Model shown - code CS3 11H1 WT

SADDLE STOOL

C	S	3	1	1				W
1	2	3	4	5	6	7	8	9



Model shown - code CS4 11L1 WQ

RONALDO

C	S	4	1	1				W
1	2	3	4	5	6	7	8	9

upholstery color code



Basic stools



11815
FIXED STOOL
Chromed steel with beechwood seat.
Seat Ø 35 x 48 h cm



11810
SQUARE STOOL
Made from section tube, which offers maximum stability.
40 x 40 x 45 h cm



11786
SWIVEL STOOL 2
Chromed steel with beechwood seat and 5 swivel wheels. Height adjustable with screw mechanism. 60 x 40 ÷ 50 h cm



XEC001
RONDO' STOOL
A stool on a chromed base fitted with 5 casters. The backrest is designed for use as armrest as well. Height adjustable 62 - 82 cm.

Appendix II Overview on the range

With an experience spanning over several decades, Chinesport offers a range of height-adjustable treatment tables for various uses and with different structural characteristics. Our offering covers various options including tables for examination, transfer, physical therapy, manipulation, specific treatment and massage.



This is the classic range of examination and treatment tables consisting mainly of two sections, with a 68 cm-long head section that can be used as a backrest. The backrest can have positive and negative tilt adjustment: up to $+70^{\circ}/-20^{\circ}$. Height is adjusted via one of the most reliable motors available on the market. A hydraulic version is also available as an alternative. The frame is unique for its simplicity and harmonious design, which is protected by registered Community design. Some of our tables are also available with larger wheels so they can be used to transport patients. This configuration can be completed by fitting a set of safety siderails.



VisitLine



A major difference from the VISIT range is given by the head section length which is only 52 cm. For this reason, it cannot be used as a backrest, but it can be fitted with armrests to provide greater comfort for the patient when in prone position. These tables were developed for physiotherapy, osteopathy or for the so-called "Global Postural Re-education" method, and they can be configured with up to six sections to achieve different postural positions for the patient. There is also a model that can be arranged in a seated position for particular use in gynecology. Another difference from the VISIT range is that the head section has a greater tilt adjustment, i.e. positive tilt up to $+85^{\circ}$ and negative tilt up to -35° , plus the nose/mouth breathing hole is standard.

TherLine



This range is an alternative to the classic ranges called VISIT and THER used for examinations, treatments and physiotherapy. In particular, the distinguishing feature in these tables is that during height adjustment the individual sections remain completely motionless. This makes them particularly suitable for smaller environments or to make the best use of available space, as well as to maintain the position chosen for exercises once the pulley therapy system has been set up. You can opt for a simplified base frame and configure the head section with a backrest that is 68 cm long, instead of a smaller section, 52 cm long, that can come with armrests. The second type of head section can have positive and negative tilt adjustment: up to $+85^{\circ}/-35^{\circ}$.

uniXLine



Sinthesi

Our Sinthesi couches allow therapists to effortlessly place patients in countless myofascial stretching postures that can be easily maintained for longer periods of time and without strain. In this relaxed position, various techniques can be applied to facilitate recovery in myofascial elongation, increase joint movement range and achieve an antalgic posture as a relief from acute pain. Also, our Sinthesi tables provide the ideal starting position for exercises that stimulate central activation and for isometric muscular work.



TestLine

This is a range of multi-functional tables for examination and for specific treatments. In particular, they can be used in podiatry, gynecology, urology, cardiology, geriatrics, beauty, phlebotomy or even to transport patients within care facilities. The table height can be adjusted electrically or via hydraulic piston, while the moving sections are servo-assisted by gas spring. In some versions, the seating section is tilt-adjustable via another motor. As a result, these tables can easily change into a seated, relaxation, Trendelenburg and anti-Trendelenburg position even with the patient lying on the table. Finally, specialized accessories are available to suit individual uses.



Marcusline

The product code for Chinesport Tilt tables depends on the configuration of the various options available. Each position in the code has a specific meaning, and corresponds to one or more characteristics of the product. Specifically, it is possible to choose a base model for static exercises from a prone or supine position, both for pediatric or adult use. The model chosen can be later modified with the necessary accessories. Tilt regulation of the table can be done by means of a hydraulic piston or electrically, either from a wall-power source or a 24V rechargeable battery. The adjustment controls can be hand or foot operated. Different choices for the patient's support surface are available. This does not preclude, eventually, the possibility to interchange the different footplate modules available. It is possible to choose any of the two possibilities for the width of the padded sections and it is possible to choose among 24 different colors of synthetic leather upholstery. A wide range of accessories can contribute to a further furnishing of the static therapy table.



AluX Eva

With this range, Chinesport is branching out into beauty, spa and massage tables for the first time, and introduces some additional optional features such as the sections heated at three different temperatures and the synthetic leather upholstery that covers the sides to produce a softer padding effect on the contact surface. Among other noteworthy options, there is a possibility to choose a led lights configuration for combining chromotherapy effects, and even when there is only one option of section width or padding density/thickness clients can request personalized features and options. These tables have two motors, so they can achieve the Trendelenburg and anti-Trendelenburg position via a dual telescopic column system.



Chinesport is an Italian company established in 1976. The company name is the result of the original matching of the Italian word "chinesiterapia" (kinesitherapy) and "sport". It was meant to be an acknowledgement to the "culture of motion", as a proposal for prevention and care. CHINESPORT is today a leading company, specialized in a wide range of rehabilitation equipment and assistive devices.

The organization has been working with a certified quality system management in compliance with the international standards ISO 9001 and ISO 13485 since 1998. The product quality is guaranteed by the CE mark, after fulfilling all the essential requirements of the European Directive 93/42/EEC. The company also has its own medical-scientific training and educational program for specialised sectors and its own equipment in support of professionals and international partners. The company has business relationships in almost 80 countries, and a new edition of its general catalogue is periodically issued.



CHINESPORT spa - Via Croazia, 2 - 33100 Udine - Italy
Phone 0432 621 621 - Fax 0432 621 620 - export@chinesport.it

www.chinesport.com