



# aquatix®

equipment for very aquatix people

AQUAFITNESS ADVANCED



**EAA**  
EUROPEAN AQUATIC ASSOCIATION

Release: 2020, March

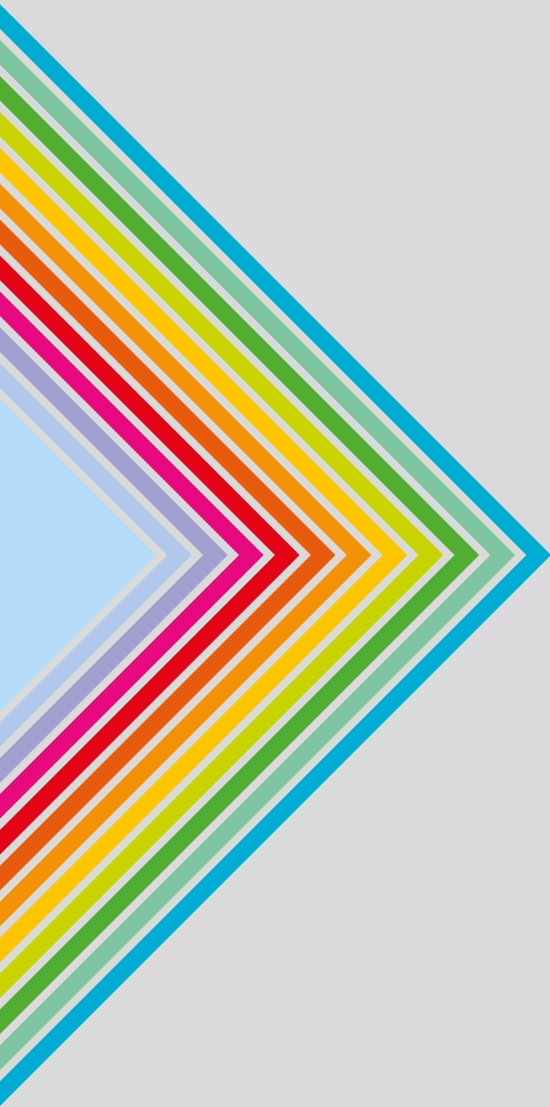

## Index

5	<b>BPM AQUABIKE</b>
7	<b>ACTIVE AQUABIKE</b>
9	<b>SMART UP + AQX AQUABIKES</b>
11	<b>GALAXY AQUABIKE</b>
15	<b>STAR AQUATREADMILL</b>
17	<b>STANDARD AQUATREADMILL</b>
21	<b>MOON WALKER</b>
23	<b>ROUND JUMP</b>
25	<b>WATER UP &amp; DOWN</b>
29	<b>FLOAT2FITNESS</b>
31	<b>VERTICAL DYNAMIC</b>
33	<b>AQUA FITNESS BOARD</b>
35	<b>SUP</b>
37	<b>PUZZLE STEP</b>
39	<b>MOON BITE &amp; AQQUA CIRCLE STEP</b>
19	<b>Circuit examples</b>



YouTube links

## Icons



**CORSI DI FORMAZIONE\***  
TRAINING COURSES\*



**CARATTERISTICHE TECNICHE**  
TECHNICAL FEATURES



**ESEMPI CIRCUITI**  
CIRCUIT EXAMPLES



\* Tutti i prodotti Aqqatix sono raccomandati da EAA

\* All Aqqatix products are recommended by EAA

[www.euroaquatic.it](http://www.euroaquatic.it)



AQUABIKE



## BPM AQUABIKE TWO

- + AQUABIKE MADE IN ITALY
- + EXCLUSIVE ITALIAN DESIGN
- + SCOCCA IN POLIETILENE  
POLYETHYLENE SHELL
- + REGOLAZIONE INTENSITÀ PEDALATA  
BRAKING SYSTEM
- + MANUBRIO ERGONOMICO  
ERGONOMIC HANDLEBAR
- + PRODOTTO MARCHIATO CE  
CE MARKED PRODUCT
- + NUOVE BASI RINFORZATE  
NUOVE BASI RINFORZATE

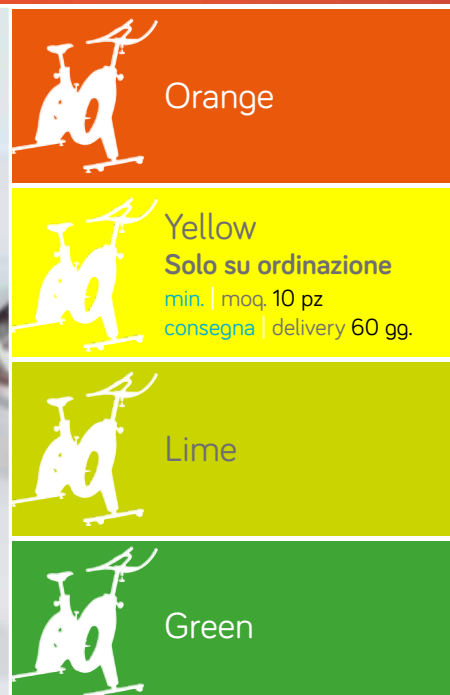



### EAA INSTRUCTOR TRAININGS:

Master **AQUABIKE**

Master **AQUA CIRCUIT**

Master **AQUAxFIT®**

Course **AQUA PERSONAL PROGRAM**



**Materiale**  
Material

Polietilene  
Inox AISI 316L

**Profondità d'impiego**  
Depth of use

100 - 140 cm

**Intensità pedalata**  
Cycling intensity

Regolabile  
Adjustable

**Peso**  
Weight

26 kg

### QUALI VENTOSE SCEGLIERE? WHICH KIND OF SUCTION CUP?



**AFA RGEN 003**  
consigliata per vasche con **SUPERFICI LISCE** (pvc liscio, ceramica liscia...) suggested for **SMOOTH SURFACE** pools (smooth pvc, smooth ceramic...)



**AFA RGEN A03**  
consigliata per vasche con **SUPERFICI SEMI RUVIDE O IRREGOLARI** (mosaico, inox bugnato, ceramica ruvida, pvc ruvido...) suggested for **UNEVEN OR IRREGULAR SURFACE** pools (mosaic, embossed stainless steel, rough ceramic ruvida, rough pvc...)

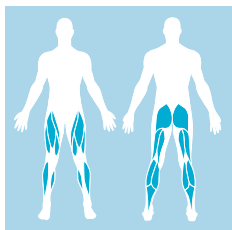

BPM AQUABIKE è la migliore soluzione per qualsiasi attività dove la pedalata è la forma principale di movimento.

- Design unico al mondo, elegante e funzionale: scocca in polietilene e telaio inox con profili ovali.
- Il freno, studiato dal Centro R&D per una maggiore durata nel tempo, permette di modificare l'intensità della pedalata anche durante l'utilizzo, senza interruzioni dell'esercizio.
- Manubrio ergonomico, studiato per diversificare la posizione delle mani e verniciato per migliorare il grip della presa.
- Pedale resistivo in polietilene, design studiato per rendere più fluida ed efficace la pedalata.
- L'eccellente stabilità della bike è assicurata dal perfetto equilibrio avantreno/retrotreno, dalle nuove basi rinforzate e dalle quattro ventose in pvc trasparente.
- L'angolo sella-manubrio di 74°, assicura la miglior posizione nell'utilizzo, escludendo regolazioni orizzontali della sella.
- Le ruote anteriori agevolano la movimentazione della bike durante l'uscita dall'acqua e a bordo vasca.
- 3 varianti colore d'effetto, con possibilità di ordinare anche la variante Yellow, con minimo d'ordine 10 pz. e 60 gg di consegna.

BPM AQUABIKE is the best solution for any activity where pedalling is the main form of movement.

- Unique design, elegant and functional: polyethylene shell and stainless steel frame with oval profiles.
- The brake, designed by the R&D Centre to achieve greater durability, allows you to change the pedalling intensity even while the bike is being used, without interrupting the exercise.
- Ergonomic handlebar, designed to increase the hand positions and painted to improve grip.
- Resistive polyethylene pedal, designed to make pedalling smoother and more effective.
- The excellent stability of the bike is ensured by the perfect balance between the front and rear axes, thanks to its new reinforced bases and four suction cups in transparent PVC.
- The 74° seat-handlebar angle ensures the best position during use, excluding horizontal seat adjustments.
- The front wheels facilitate the movement of the bike when exiting the water and on the poolside.
- 3 dazzling colour variants, plus the option of ordering the Yellow variant, with a minimum order of 10 pieces and delivery within 60 days.

## BPM AQUABIKE

mod. **TWO**

cod. AFA BPM 002

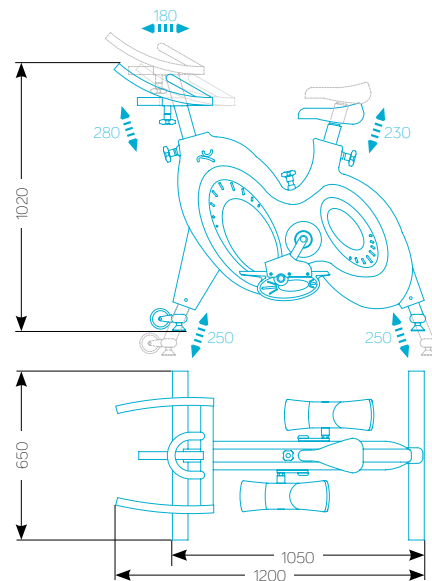



Regolazione orizzontale manubrio  
Horizontal handlebar adjustment

Manubrio ergonomico verniciato  
Ergonomic varnished handlebar

Il sistema di regolazione dell'intensità di pedalata di **ACTIVE AQUABIKE** permette di modificare la resistenza, anche durante l'attività, senza interruzioni  
The **ACTIVE AQUABIKE's** exclusive pedalling intensity adjustment system allows you to adjust the resistance, even during the activity, without any interruptions



Profili tondi antinfortunio  
Round safety bars

Regolazione meccanica intensità della pedalata  
Mechanical intensity adjustment

## ACTIVE AQUABIKE

- + AQUABIKE MADE IN ITALY
- + EXCLUSIVE ITALIAN DESIGN
- + PROFILI TONDI ANTINFORTUNIO  
ROUND SAFETY BARS
- + REGOLAZIONE INTENSITÀ PEDALATA  
BRAKING SYSTEM
- + MANUBRIO ERGONOMICO  
ERGONOMIC HANDLEBAR
- + PRODOTTO MARCHIATO CE  
CE MARKED PRODUCT



Alloggio piede in Eva Foam  
Foot rest in Eva Foam

Pedale resistivo  
Resistive pedal

Nuovo alloggio del piede in Eva Foam  
New foot rest in Eva Foam



Versione in acciaio verniciato nero  
Black painted frame version

Ventose trasparenti antimacchia  
Non-staining suction caps

Ruote gommata  
Rubber wheels

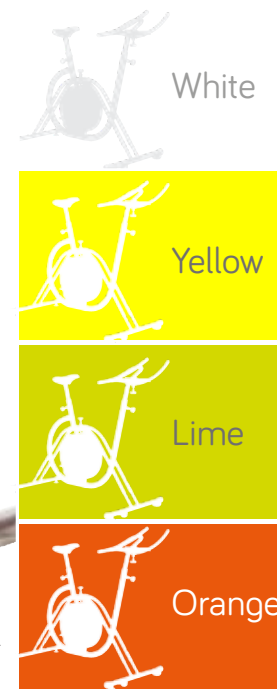

White

Yellow

Lime

Orange



### EAA INSTRUCTOR TRAININGS:

Master **AQUABIKE**

Master **AQUA CIRCUIT**

Master **AQUAxFIT®**

Course **AQUA PERSONAL PROGRAM**



**Materiale**  
Material

Inox AISI 316L  
316 L stainless steel

**Profondità d'impiego**  
Depth of use

100 - 140 cm

**Intensità pedalata**  
Cycling intensity

Regolabile  
Adjustable

**Peso**  
Weight

22,5 kg

### QUALI VENTOSE SCEGLIERE? WHICH KIND OF SUCTION CUP?



**AFA RGEN 003**  
consigliata per vasche con **SUPERFICI LISCE** (pvc liscio, ceramica liscia...) suggested for **SMOOTH SURFACE** pools (smooth pvc, smooth ceramic...)



**AFA RGEN A03**  
consigliata per vasche con **SUPERFICI SEMI RUVIDE O IRREGOLARI** (mosaico, inox bugnato, ceramica ruvida, pvc ruvido...) suggested for **UNEVEN OR IRREGULAR SURFACE** pools (mosaic, embossed stainless steel, rough ceramic ruvida, rough pvc...)

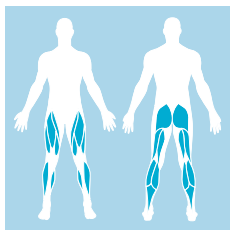

ACTIVE è Il modello di Aquabike in acciaio inox, ottimo per qualsiasi attività dove la pedalata è la forma principale di movimento, dal design unico, elegante e funzionale.

- Carter in 4 varianti colore d'effetto, è studiato per la sicurezza durante la pedalata.
- Il freno, studiato dal Centro R&D per una maggiore durata nel tempo, permette di modificare la resistenza, anche durante l'attività, senza interruzioni dell'esercizio.
- Telaio in acciaio con profili arrotondati, verniciato nel mod. BLACK.
- Manubrio ergonomico, studiato per diversificare la posizione delle mani e verniciato per migliorare il grip della presa.
- Pedale resistivo in polietilene, dal design studiato per rendere più fluida ed efficace la pedalata.
- Ottima stabilità, assicurata dal perfetto equilibrio avantreno/retrotreno, dalle basi ben dimensionate e dalle quattro ventose in pvc trasparente.
- L'angolo sella-manubrio di 74°, assicura la miglior posizione nell'utilizzo, escludendo regolazioni orizzontali della sella.
- Le ruote anteriori agevolano la movimentazione della bike durante l'uscita dall'acqua e a bordo vasca.

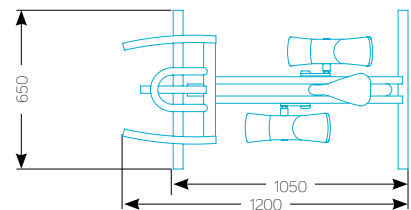
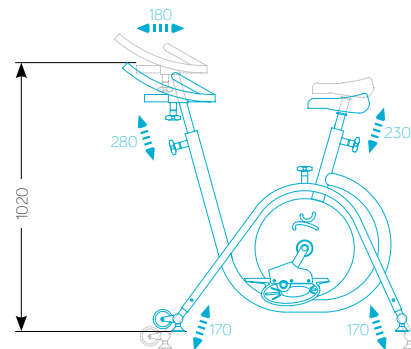

ACTIVE is the Aquabike model in stainless steel, excellent for any activity where pedalling is the main form of movement, with a unique, elegant and functional design.

- Carter in 4 dazzling colour variants, designed to ensure safety while pedalling.
- The brake, designed by the R&D Centre to achieve greater durability, allows you to change the resistance, even during the activity, without interrupting the exercise.
- Steel frame with rounded profiles, BLACK model.
- Ergonomic handlebar, designed to increase the hand positions and painted to improve grip.
- Resistive polyethylene pedal, designed to make pedalling smoother and more effective.
- Excellent stability, ensured by the perfect balance between front and rear axes, well-sized bases and four suction cups in transparent PVC.
- The 74° seat-handlebar angle ensures the best position during use, excluding horizontal seat adjustments.
- The front wheels facilitate the movement of the bike when exiting the water and on the poolside.



**ACTIVE AQUABIKE**  
cod. AFA 0002 PRW mod. **ACCIAIO**  
cod. AFA 0002 N PRW mod. **BLACK**



Carter colorato e pedale con alloggiamento piede in Eva Foam  
Coloured case and new foot rest in Eva Foam

## SMART UP AQUABIKE

- + EXCLUSIVE ITALIAN DESIGN, MADE IN ITALY
- + INGOMBRO E PESO CONTENUTI  
COMPACT SIZE AND LOW WEIGHT
- + ALLOGGIO PIEDE CONFORTEVOLE  
COMFORTABLE PEDAL COVER
- + PRODOTTO MARCHIATO CE  
CE MARKED PRODUCT
- + BASE EXTRALONG (OPZIONALE)  
EXTRA LONG BASE (OPTIONAL)

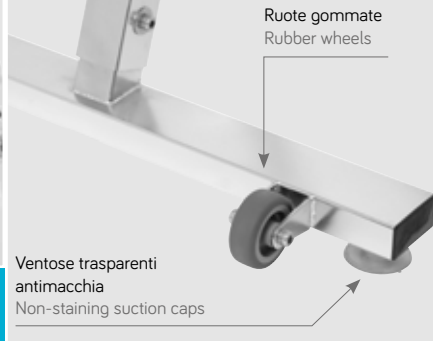

Ordinabile anche in versione Long  
Also available in the Long version

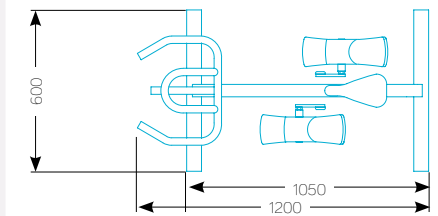
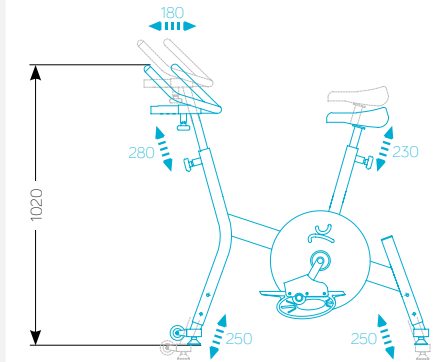

White Yellow Lime Orange

## AQX AQUABIKE

- + AQUABIKE MADE IN ITALY
- + ACCESSORI AGGIUNTIVI  
ADDITIONAL ACCESSORIES
- + SMILE PRICE BIKE
- + PEDALE RESISTIVO  
RESISTIVE PEDAL
- + PESO E INGOMBRO CONTENUTI  
COMPACT SIZE AND LOW WEIGHT
- + ALLOGGIO PIEDE CONFORTEVOLE  
COMFORTABLE FOOT HOLDER



Ordinabile anche mod. Full Optional  
Full Optional model also available

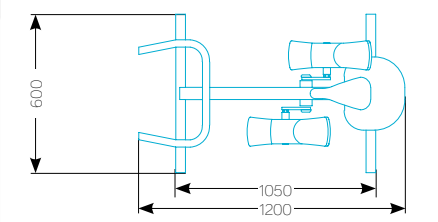
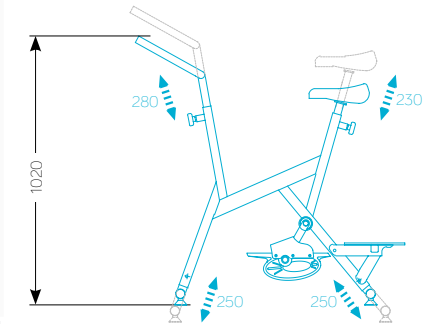





### EAA INSTRUCTOR TRAININGS:

Master **AQUABIKE**

Master **AQUA CIRCUIT**

Master **AQUAxFIT®**

Course **AQUA PERSONAL PROGRAM**



### mod. SMART UP + LONG SMART UP

<b>Materiale</b> Material	Inox AISI 316L 316 L stainless steel
<b>Profondità d'impiego</b> Depth of use	<b>SMART UP</b> 100 - 140 cm <b>L SMART UP</b> 100 - 180 cm
<b>Peso</b>	AFA 0013 019 21 kg
<b>Weight</b>	AFA 0015 019 23 kg

### mod. AQX + AQX FULL OPTIONAL

<b>Materiale</b> Material	Inox AISI 304 304 stainless steel
<b>Profondità d'impiego</b> Depth of use	100 - 140 cm
<b>Peso</b>	AFA AQX 001 14 kg
<b>Weight</b>	AFA AQX 001 FO 16 kg

### QUALI VENTOSE SCEGLIERE? WHICH KIND OF SUCTION CUP?



**AFA RGEN 003**  
consigliata per vasche con **SUPERFICI LISCE** (pvc liscio, ceramica liscia...) suggested for SMOOTH SURFACE pools (smooth pvc, smooth ceramic...)



**AFA RGEN A03**  
consigliata per vasche con **SUPERFICI SEMI RUVIDE O IRREGOLARI** (mosaico, inox bugnato, ceramica ruvida, pvc ruvido...) suggested for UNEVEN OR IRREGULAR SURFACE pools (mosaic, embossed stainless steel, rough ceramic ruvida, rough pvc...)

SMART AQUABIKE è la soluzione per chi necessita di un prodotto di qualità, ma ideato per utilizzi meno intensivi, come stagionali o target più giovane.

- Carter colorato, in 4 varianti, che valorizza l'estetica oltre a garantirne la sicurezza attiva durante la pedalata.
- Sistema di resistenza determinato dal pedale resistivo, con nuovo alloggiamento del piede in Eva Foam per una confortevole calzata, anche a piede nudo.
- Telaio con profilati quadrati.
- Stabilità e solidità assicurano affidabilità e ridottissima manutenzione.
- Regolazione verticale di sella e manubrio: esaustive per comfort in uso grazie all'angolo di 74° del telaio (*esclusiva Aquatix*)
- **Opzionale: sistema di regolazione dell'altezza per vasche fino a 180 cm.**

SMART AQUABIKE is the ideal solution for those who need a quality product, but it is also designed for less intensive uses, aimed at seasonal clients or a younger target public.

- Coloured carter, in 4 variants, which enhances the aesthetics as well as ensuring active safety during pedalling.
- Resistance system determined by the resistive pedal, with new Eva Foam foot rest to ensure a comfortable fit, even with bare feet.
- Frame with square profiles.
- Stability and solidity ensure reliability and very low maintenance.
- Vertical saddle and handlebar adjustment: ensuring comfortable use thanks to the 74 ° angle of the frame (*Aquatix exclusive*)
- **Optional: height adjustment system for pools up to 180 cm deep.**

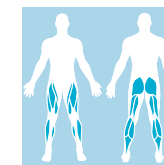

### MODELLO PRODOTTO SOLO SU RICHIESTA: minimo quantitativo 50 pz.

Aquabike stazionaria dalla linea essenziale, solida e versatile, realizzata nelle versioni **Standard** e **Full Optional**.

- Dimensioni ridotte per gestire al meglio gli spazi
- Pedale resistivo per una pedalata più fluida ed efficace, con confortevole alloggiamento del piede in gomma.
- L'angolo sella-manubrio di 74°, assicura la miglior posizione nell'utilizzo escludendo regolazioni orizzontali della sella.
- Full Optional: accessori che permettono di ampliare la gamma di esercizi.

### MODEL EXCLUSIVELY ON REQUEST: minimum quantity of 50 pieces

Stationary Aquabike with essential lines, solid and versatile, comes in both a **Standard** and a **Full Optional** version.

- Small size to better manage spaces
- Resistive pedal designed to make pedalling smoother and more effective, with comfortable rubber foot rest.
- The 74° saddle-handlebar angle ensures the best position during use excluding horizontal saddle adjustments.
- Full Optional: accessories that allow you to expand the range of exercises.

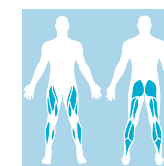

### SMART UP AQUABIKE

cod. AFA 0013 019 mod. **STANDARD**

cod. AFA 0015 019 mod. **LONG**

### AQX AQUABIKE

cod. AFA AQX 001 mod. **STANDARD**

cod. AFA AQX 001 FO mod. **FULL OPTIONAL**

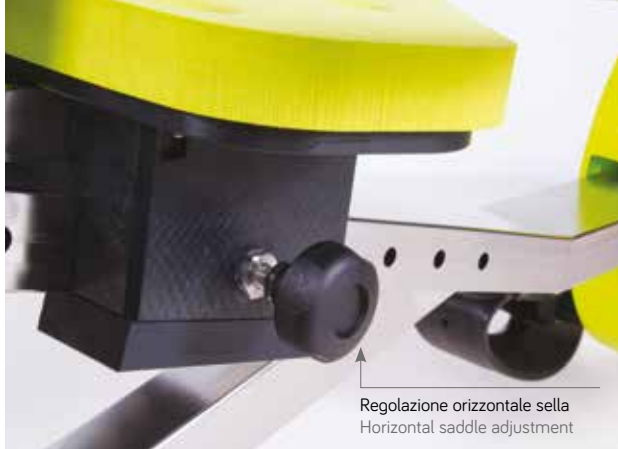

## GALAXY AQUABIKE

- + AQUABIKE MADE IN ITALY
- + EXCLUSIVE ITALIAN DESIGN
- + INGOMBRI RIDOTTI  
REDUCED OBSTRUCTION
- + SISTEMA REGOLAZIONE INTENSITÀ  
INTENSITY REGULATION SYSTEM
- + REGOLAZIONE ORIZZONTALE DA SEDUTI  
SEAT ADJUSTMENT
- + IDEALE PER VASCHE MOLTO BASSE  
IDEAL FOR SHALLOW POOLS
- + PRODOTTO MARCHIATO CE  
CE MARKED PRODUCT





### EAA INSTRUCTOR TRAININGS:

Master **AQUA CIRCUIT**

Course **AQUA PERSONAL PROGRAM**



<b>Materiale</b> Material	Inox AISI 316L 316 L stainless steel
<b>Profondità d'impiego</b> Depth of use	70 - 100 cm
<b>Intensità pedalata</b> Cycling intensity	Regolabile Adjustable
<b>Peso</b> Weight	21 kg

### QUALI VENTOSE SCEGLIERE? WHICH KIND OF SUCTION CUP?



**AFA RGEN 003**  
consigliata per vasche con **SUPERFICI LISCE** (pvc liscio, ceramica liscia...)  
suggested for **SMOOTH SURFACE** pools  
(smooth pvc, smooth ceramic...)



**AFA RGEN A03**  
consigliata per vasche con **SUPERFICI SEMI RUVIDE O IRREGOLARI**  
(mosaico, inox bugnato, ceramica ruvida, pvc ruvido...)  
suggested for **UNEVEN OR IRREGULAR SURFACE** pools  
(mosaic, embossed stainless steel, rough ceramic ruvida, rough pvc...)

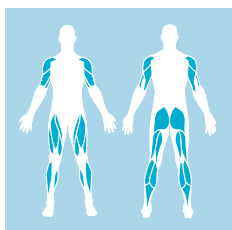

GALAXY è l'Aquabike orizzontale ideata dal centro R&D di Aquatix per vasche di profondità contenuta tra 70-100 cm.

- Pensata per facilitare il training di chi ha patologie lombari o necessita progressivamente di attivare gli arti inferiori.
- Ottima per qualsiasi persona e per un allenamento completo (attivando anche le braccia), giovandosi della quasi completa immersione del busto, come non è possibile con le Aquabike verticali.
- Indicata anche per circuiti e percorsi/protocolli riabilitativi.
- Pedale resistivo in polietilene, dal design studiato per rendere più fluida ed efficace la pedalata.

GALAXY is the horizontal Aquabike created by the Aquatix R&D Centre for pools 70-100 cm deep.

- Designed to facilitate the training of people with lumbar pathologies or who need to progressively activate their lower limbs.
- Excellent for any person and for a complete workout (it also activates the arms), taking advantage of the almost complete immersion of the torso, which is not possible with vertical Aquabikes.
- Also suitable for rehabilitation circuits and routes/protocols.
- Resistive polyethylene pedal, designed to make pedalling smoother and more effective.

## GALAXY AQUABIKE

cod. AFA 0801 PRW

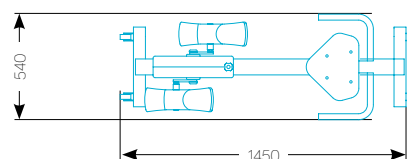
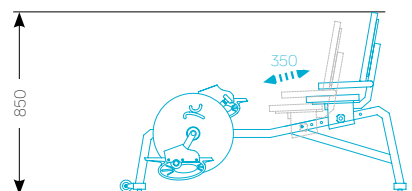

# AQUABIKES



Sinistra AFA RPED SNL  
Destra AFA RPED SNR  
**Pedale Neoprene**  
Neoprene Pedal



BAQ 0001  
**Borraccia**  
Bottle



BAQ 0002  
**Porta Borraccia**  
Bottle Cage



AFA RGEN A03  
**Ventosa blu**  
Blue suction cap



BPM AFA RBPM L04  
Smart AFA 0015 019  
**Prolunga altezza**  
Length ext.



AFA AQX 002  
**Step posteriore**  
Rear step



AFA AQX 003  
**Manubrio post.**  
Rear handlebar



AFA 0400  
**Elastici**  
Elastics



AFO 0300  
**Parabordo**  
Board guard



AFO PEA  
**Pedane in inox**  
Platforms

**Optional**  
Su richiesta | On request

AFA BPM 002 <b>BPM AQUABIKE TWO</b>	✓	✓	✓	✓	✓	-	-	✓*	✓	✓
AFA 0002 PRW   AFA 0002 N PRW <b>ACTIVE AQUABIKE</b>	✓	✓	✓	✓	-	-	-	✓*	✓	✓
AFA 0013 019 <b>SMART UP AQUABIKE</b>	✓	✓	✓	✓	✓	-	-	✓*	✓	✓
AFA AQX 001   AFA AQX 001 FO <b>AQX AQUABIKE</b>	✓	✓	✓	✓	-	✓	✓	✓	✓	✓
AFA 0801 PRW <b>GALAXY AQUABIKE</b>	✓	-	-	✓	-	-	-	-	-	✓

\*È necessario aggiungere Vite con Anello, cod. AFA RGEN 072 | \* it is necessary to add Screw Eyes, cod. AFA RGEN 072

<b>Dettagli</b> Tecnici   Technical		Materiale Material	Ingombro minimo Minimum bulk	Profondità d'impiego Depth of use	Intensità pedalata Cycling intensity	Peso Weight
AFA BPM 002 <b>BPM AQUABIKE TWO</b>		Polietilene, Inox 316 L Polyethylene, st. 316 L	1050 x 650 mm	100 - 140 cm	Regolabile Adjustable	26 kg
AFA 0002 PRW   AFA 0002 N PRW <b>ACTIVE AQUABIKE</b>		Inox AISI 316L Stainless steel 316 L	1050 x 650 mm	100 - 140 cm	Regolabile Adjustable	22,5 kg
AFA 0013 019   AFA 0015 019 <b>SMART UP AQUABIKE</b>		Inox AISI 316L Stainless steel 316 L	1050 x 600 mm	100 - 140 cm 140 - 180 cm	-	21 kg
AFA AQX 001   AFA AQX 001 FO <b>AQX AQUABIKE</b>		Inox AISI 304 L Stainless steel 316 L	1050 x 600 mm	100 - 130 cm	-	14 kg   16 kg
AFA 0801 PRW <b>GALAXY AQUABIKE</b>		Inox AISI 316L Stainless steel 316 L	1450 x 540 mm	70 - 100 cm	Regolabile Adjustable	21 kg

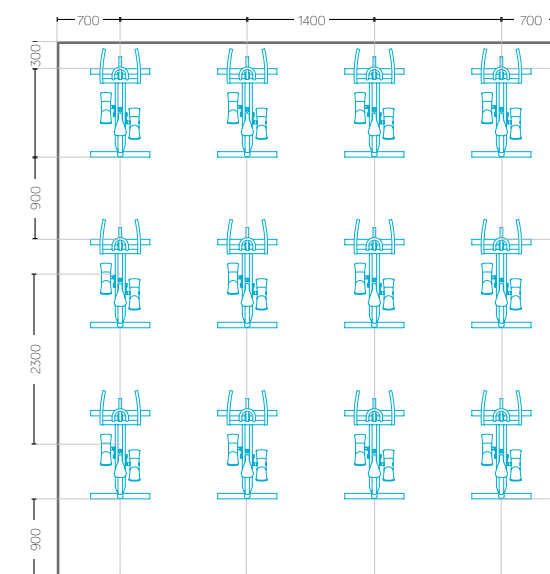

AQUATREADMILLS

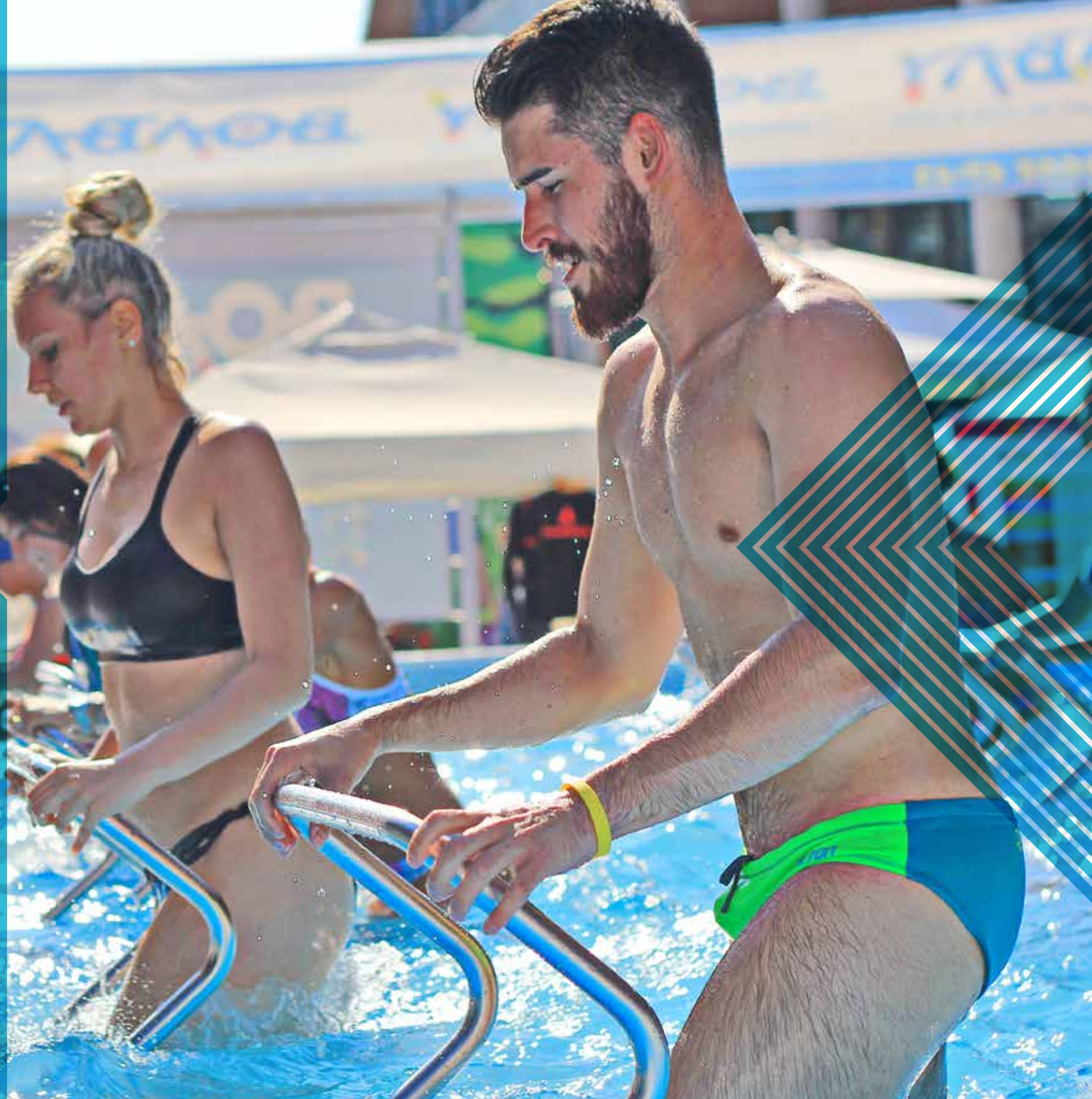



Il sistema di scorrimento del nastro a tre rulli di **STAR AQUATREADMILL** garantisce la massima fluidità e scorrevolezza: è l'unico che consente la corsa in acqua

The STAR AQUATREADMILL three-roll sliding system guarantees maximum fluidity and smoothness: it is the only kind that allows running in the water



## STAR AQUATREADMILL

- + TREADMILL MADE IN ITALY
- + EXCLUSIVE ITALIAN DESIGN
- + SCOCCA IN POLIETILENE  
POLYETHYLENE SHELL
- + OTTIMO SCORRIMENTO DEL NASTRO  
EXCELLENT BELT SLIDING
- + AMPIA PEDANA LATERALE  
LARGE LATERAL FOOTBOARD
- + PRODOTTO MARCHIATO CE  
CE MARKED PRODUCT
- + NUOVO COLORE "LIME"  
NEW COLOUR "LIME"

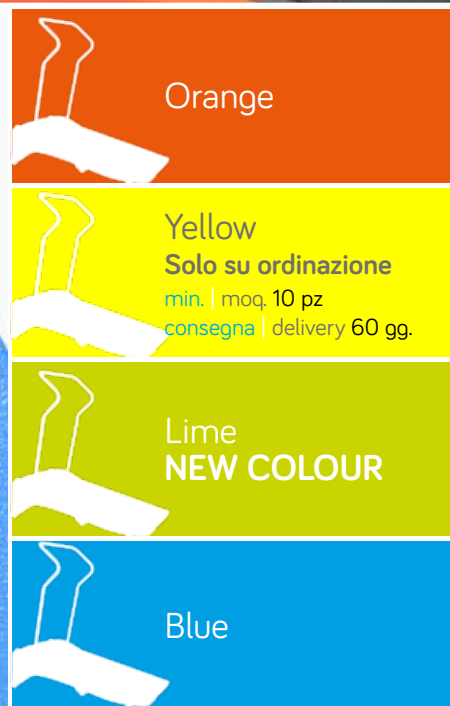



**EAA**  
EUROPEAN AQUATIC ASSOCIATION

### EAA INSTRUCTOR TRAININGS:

Master **AQUA TREADMILL**

Master **AQUA CIRCUIT**

Master **AQUAxFIT®**

Course **AQUA PERSONAL PROGRAM**



<b>Materiale</b> Material	Polietilene Inox AISI 316L
<b>Profondità d'impiego</b> Depth of use	100 - 140 cm
<b>Inclinazione pedana</b> Slope	13°
<b>Peso</b> Weight	28 kg

### QUALI VENTOSE SCEGLIERE? WHICH KIND OF SUCTION CUP?



**AFA RGEN 003**  
consigliata per vasche con **SUPERFICI LISCE** (pvc liscio, ceramica liscia...) suggested for **SMOOTH SURFACE** pools (smooth pvc, smooth ceramic...)



**AFA RGEN A03**  
consigliata per vasche con **SUPERFICI SEMI RUVIDE O IRREGOLARI** (mosaico, inox bugnato, ceramica ruvida, pvc ruvido...) suggested for **UNEVEN OR IRREGULAR SURFACE** pools (mosaic, embossed stainless steel, rough ceramic ruvida, rough pvc...)

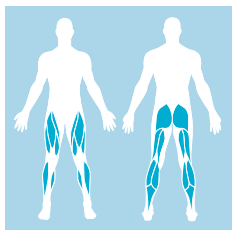

STAR Aquatreadmill è un tapis roulant meccanico, in polietilene, studiato per aqua walking e aqua running.

- Coniuga innovazione, design, funzionalità e praticità.
- Nato per walking e running in acqua, è ideale per attività con classi di allievi coordinate da istruttore, ma anche per riabilitazione e sedute mirate e personalizzate di training in acqua.
- Unico per stabilità, affidabilità e scorrevolezza del nastro.
- Compatto in chiusura, è agevolmente movimentabile sul piano vasca.
- Materiali idonei anche in caso di prolungati periodi di immersione.

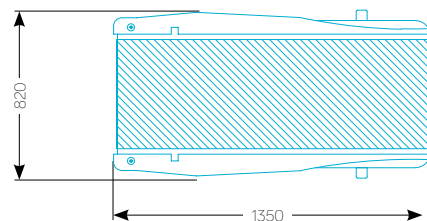
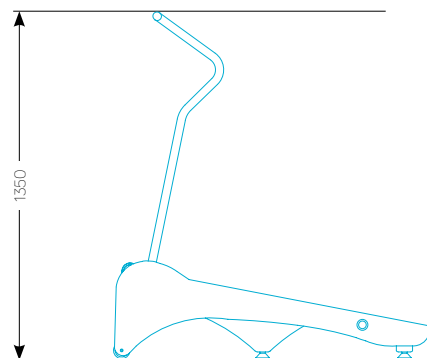
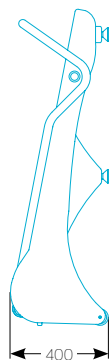

STAR Aquatreadmill is a mechanical treadmill, in polyethylene, designed for aqua walking and aqua running.

- It seamlessly combines innovation, design, functionality and practicality.
- Created for walking and running in the water, it is ideal for activities involving classes of students coordinated by an instructor, but also for rehabilitation and targeted and personalized training sessions in the water.
- Unique in terms of stability, reliability and smooth running of the belt.
- Compact when closed, it can be easily moved around the pool area.
- Materials suitable for prolonged periods of time in the water.

## STAR AQUATREADMILL

cod. AFA 0012





Chiusura di sicurezza  
Safety lock



Rulli scorrimento nastro  
Belt rollers

## STANDARD AQUATREADMILL

- + TREADMILL MADE IN ITALY
- + EXCLUSIVE ITALIAN DESIGN
- + ADATTO AD ACQUE TERMALI O SALATE  
SUITABLE FOR THERMAL OR SALT WATER
- + APPOGGIO LATERALE PER PIEDE  
SIDE FOOT REST
- + INGOMBRO RIDOTTO  
REDUCED OBSTRUCTION
- + PRODOTTO MARCHIATO CE  
CE MARKED PRODUCT

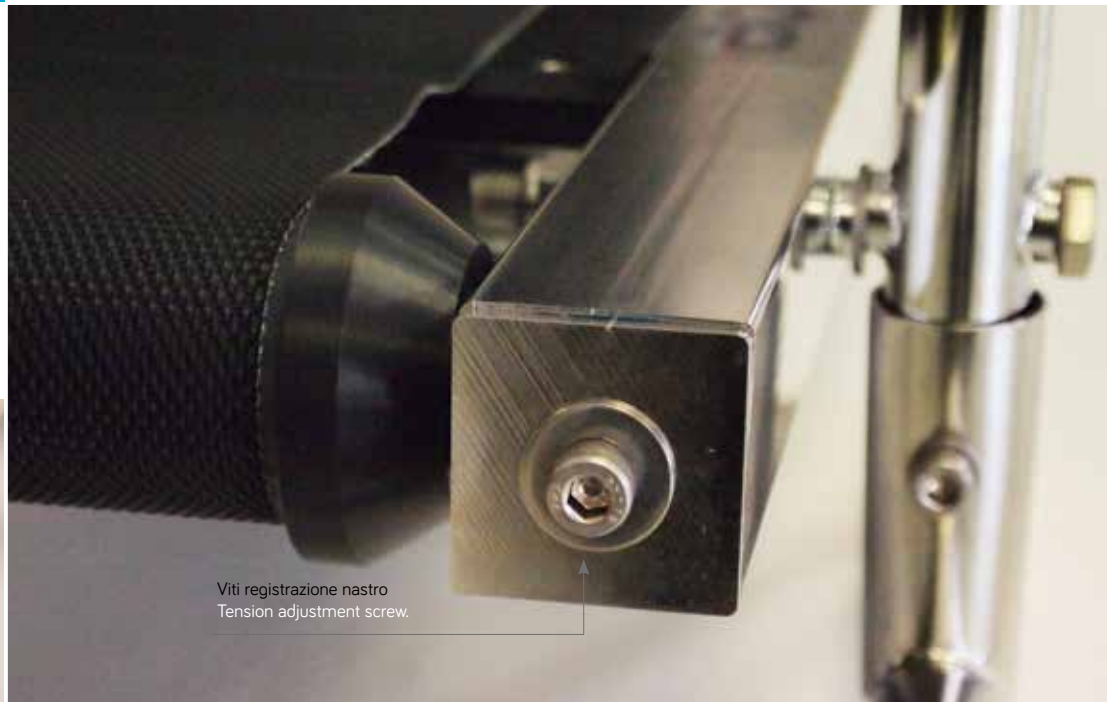

Viti registrazione nastro  
Tension adjustment screw







### EAA INSTRUCTOR TRAININGS:

Master [AQUA TREADMILL](#)

Master [AQUA CIRCUIT](#)

Master [AQUAxFIT®](#)

Course [AQUA PERSONAL PROGRAM](#)



<b>Materiale</b> Material	Inox AISI 316L 316 L stainless steel
<b>Profondità d'impiego</b> Depth of use	100 - 120 cm
<b>Inclinazione pedana</b> Slope	13°
<b>Peso</b> Weight	20 kg

### QUALI VENTOSE SCEGLIERE? WHICH KIND OF SUCTION CUP?



**AFA RGEN 003**  
consigliata per vasche con **SUPERFICI LISCE** (pvc liscio, ceramica liscia...) suggested for SMOOTH SURFACE pools (smooth pvc, smooth ceramic...)



**AFA RGEN A03**  
consigliata per vasche con **SUPERFICI SEMI RUVIDE O IRREGOLARI** (mosaico, inox bugnato, ceramica ruvida, pvc ruvido...) suggested for UNEVEN OR IRREGULAR SURFACE pools (mosaic, embossed stainless steel, rough ceramic ruvida, rough pvc...)

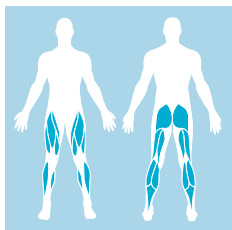

STANDARD Aquatreadmill è un tapis roulant meccanico studiato per aqua walking e aqua running.

- Ideale per attività con classi di allievi coordinate da istruttore.
- Dimensioni più contenute e peso più leggero rendono questo modello molto pratico e ideale in vasche di piccole dimensioni.
- Materiali idonei anche in caso di prolungati periodi di immersione.

STANDARD Aquatreadmill is a mechanical treadmill designed for aqua walking and aqua running.

- Ideal for activities involving classes of students coordinated by an instructor.
- Smaller dimensions and lighter weight make this model very practical and ideal for small pools.
- Resistant materials, suitable for prolonged periods of time in the water.

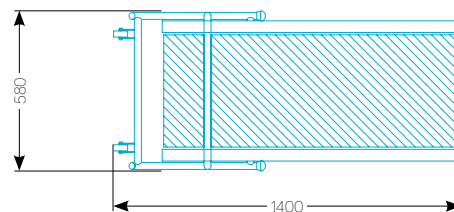
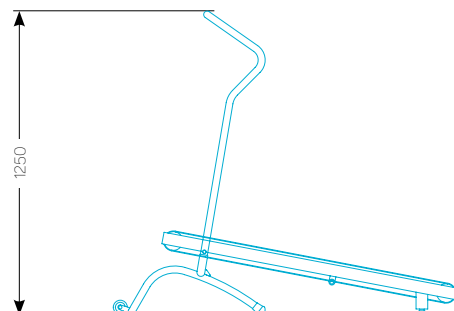
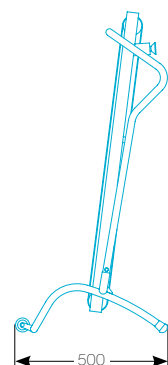

## STANDARD AQUATREADMILL

cod. AFA 0014

## AQUATREADMILL



**Optional**  
Su richiesta | On request

BAQ 0001  
**Borraccia**  
Bottle

BAQ 0002  
**Porta Borraccia**  
Bottle Cage

AFA RGEN A03  
**Ventosa blu**  
Blue suction cap

AFO 0300  
**Parabordo**  
Board guard

AFO PEA  
**Pedane in inox**  
Platforms

AFA 0012 <b>STAR AQUATREADMILL</b>	✓	✓	✓	✓	✓
AFA 0014 <b>STANDARD AQUATREADMILL</b>	✓	✓	✓	✓	✓

**Dettagli**  
Tecnici | Technical

	Materiale Material	Ingombro minimo Minimum bulk	Profondità d'impiego Depth of use	Inclinazione Slope	Peso Weight
AFA 0012 <b>STAR AQUATREADMILL</b>	Polietilene, Inox 316 L Polyethylene, st. 316 L	1350 x 820 mm	100 - 140 cm	13°	28 kg
AFA 0014 <b>STANDARD AQUATREADMILL</b>	Inox AISI 316L Stainless steel 316 L	1400 x 580 mm	100 - 120 cm	13°	20 kg

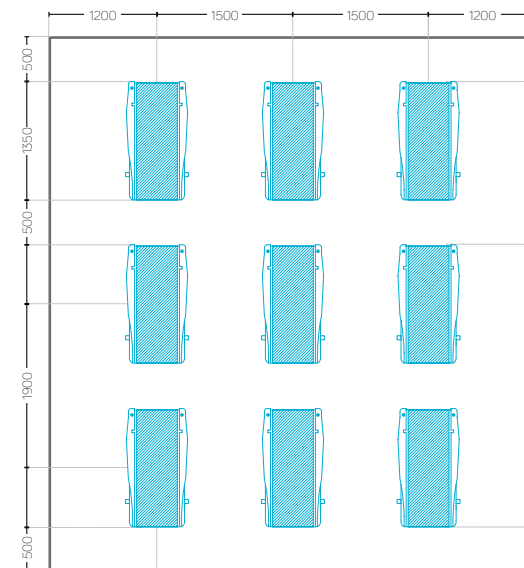

# Circuit examples

DISPOSIZIONE A RETTANGOLO  
RECTANGLE DISPOSITION

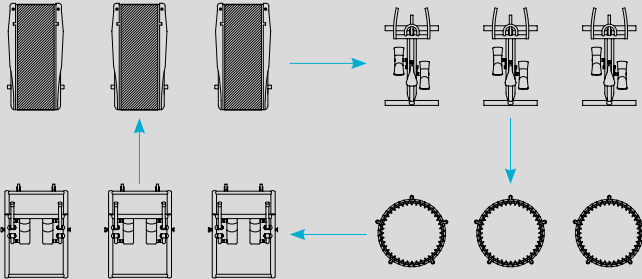

Questi sono solo alcuni esempi di circuiti e possono essere proposti con altri grandi e piccoli attrezzi

DISPOSIZIONE A X  
X DISPOSITION

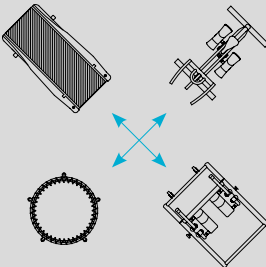

DISPOSIZIONE A Z  
Z DISPOSITION

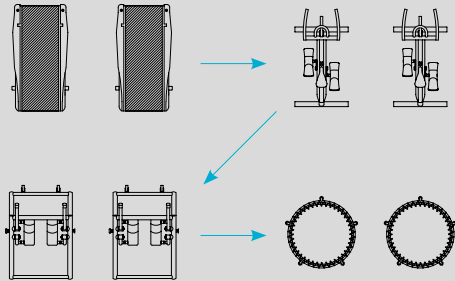

DISPOSIZIONE A MEZZA CLASSE  
DIVIDING THE CLASS INTO TWO GROUPS IN THE POOL

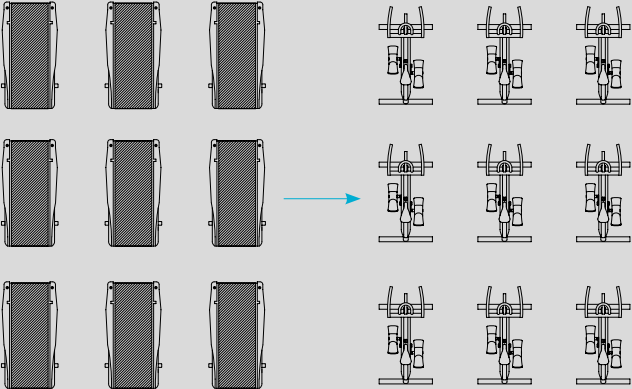

These are just a few examples of circuits and they can be prepared using other tools, both big and small



## MOON WALKER

- + EXCLUSIVE ITALIAN DESIGN, MADE IN ITALY
- + SEMPLICE MODULARITÀ DEI CARICHI  
SIMPLE ADJUSTMENT OF LOADS
- + MASSIMA STABILITÀ E SICUREZZA  
MAXIMUM STABILITY AND SAFETY
- + SIMULAZIONE DI DEAMBULAZIONE "GUIDATA"  
"GUIDED" WALKING SIMULATION
- + TRAINING E RECUPERO FUNZIONALE  
TRAINING AND FUNCTIONAL RECOVER
- + PRODOTTO MARCHIATO CE  
CE MARKED PRODUCT



Chiusura di sicurezza  
Safety lock



Impugnatura  
Handle



Ventose trasparenti antimacchia  
Non-staining suction caps



Alloggio piede in neoprene, rinforzato  
Reinforced neoprene shoe

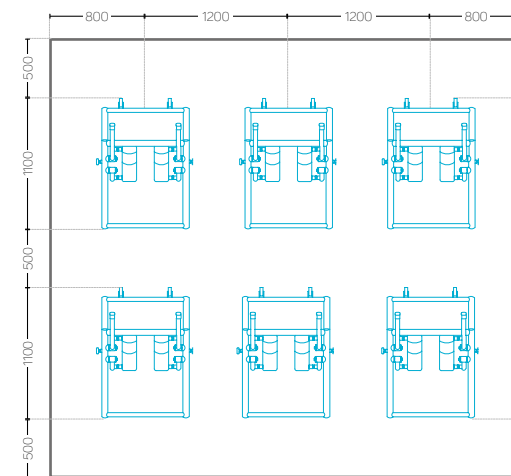



**EAA**  
EUROPEAN AQUATIC ASSOCIATION

### EAA INSTRUCTOR TRAININGS:

Master **AQUA CIRCUIT**

Master **AQUAxFIT®**

Course **AQUA PERSONAL PROGRAM**



**Materiale**  
Material

Inox AISI 316L  
316L stainless steel

**Profondità d'impiego**  
Depth of use

100 - 140 cm

**Peso**  
Weight

26 kg

### QUALI VENTOSE SCEGLIERE? WHICH KIND OF SUCTION CUP?



**AFA RGEN 003**  
consigliata per vasche con **SUPERFICI LISCE** (pvc liscio, ceramica liscia...) suggested for **SMOOTH SURFACE** pools (smooth pvc, smooth ceramic...)



**AFA RGEN A03**  
consigliata per vasche con **SUPERFICI SEMI RUVIDE O IRREGOLARI** (mosaico, inox bugnato, ceramica ruvida, pvc ruvido...) suggested for **UNEVEN OR IRREGULAR SURFACE** pools (mosaic, embossed stainless steel, rough ceramic ruvida, rough pvc...)

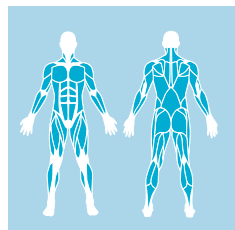

MOON WALKER è un attrezzo multifunzione che riproduce il movimento ispirato al Nordic Walking, ma in condizioni di parziale gravità dovuta all'immersione.

- Permette di allenare contemporaneamente gambe e braccia.
- Efficace anche nell'impiego dei soli arti superiori, che possono accompagnare il movimento delle gambe o essere attivi nello sforzo.
- Attrezzo costruito con materiale idoneo a rimanere in acqua per lungo periodo.

MOON WALKER is a multifunctional equipment that reproduces a form of walking or running in less gravity, a movement inspired by Nordic Walking.

- Allows simultaneous training of legs and arms.
- Also effective in the use of only the upper limbs, which may accompany the movement of the legs or be active in the effort.
- Resistant materials, suitable for prolonged periods of time in the water.

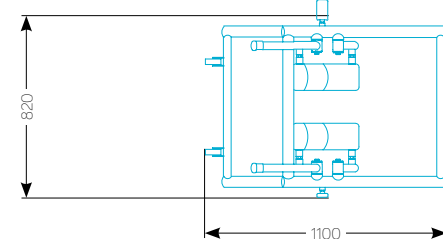
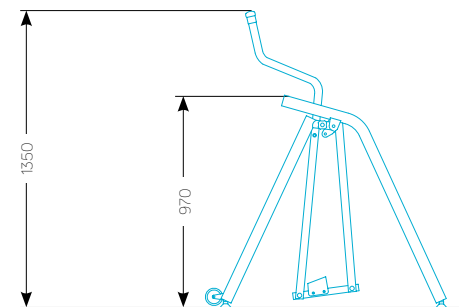
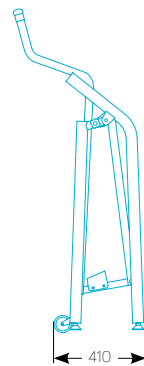

CE



## MOON WALKER

cod. AFA 0150 mod. **ACCIAIO**

cod. AFA 0150 N mod. **BLACK**



Ventose trasparenti antimacchia  
Non-staining suction caps

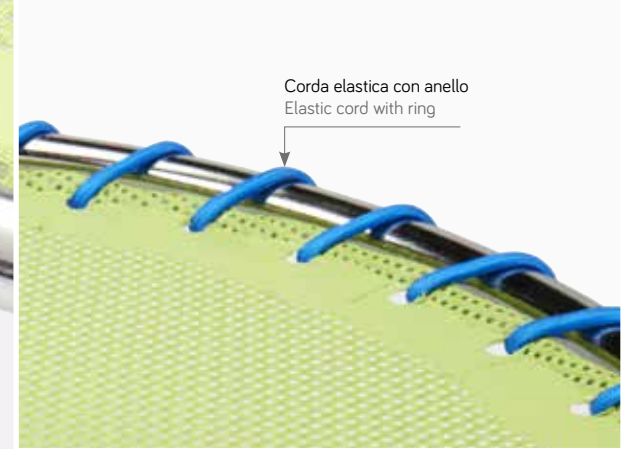

Corda elastica con anello  
Elastic cord with ring



## ROUND JUMP

- + JUMP MADE IN ITALY
- + EXCLUSIVE ITALIAN DESIGN
- + AMPIA AREA DI LAVORO  
LARGE WORKING AREA
- + IMPILABILE A BORDO VASCA  
CAN BE STACKED ON POOL SIDE
- + OTTIMA RISPOSTA ELASTICA DEL TELO  
EXCELLENT MAT ELASTICITY





### EAA INSTRUCTOR TRAININGS:

Master **AQUA STEP & JUMP**

Master **AQUA CIRCUIT**

Master **AQUAxFIT®**

Course **AQUA PERSONAL PROGRAM**



Materiale Material	Inox AISI 316L 316L stainless steel
Profondità d'impiego Depth of use	100 - 150 cm
Ventose Suction cup	5
Peso Weight	5 kg

### QUALI VENTOSE SCEGLIERE? WHICH KIND OF SUCTION CUP?



**AFA RGEN 003**  
consigliata per vasche con **SUPERFICI LISCE** (pvc liscio, ceramica liscia...)  
suggested for **SMOOTH SURFACE** pools  
(smooth pvc, smooth ceramic...)



**AFA RGEN A03**  
consigliata per vasche con **SUPERFICI SEMI RUVIDE O IRREGOLARI**  
(mosaico, inox bugnato, ceramica ruvida, pvc ruvido...)  
suggested for **UNEVEN OR IRREGULAR SURFACE** pools  
(mosaic, embossed stainless steel, rough ceramic ruvida, rough pvc...)

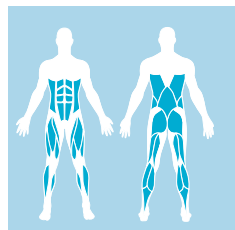

ROUND JUMP è un attrezzo resistente e leggero, ottimo per attività in acqua.

- Ideale per lezioni di fitness in acqua generiche, di gruppo, ma anche in ottica di preparazione atletica e rieducazione funzionale.
- Minimo ingombro di più attrezzi fuori dall'acqua.

ROUND JUMP is a lightweight and strong workout gear, excellent for water activities.

- Ideal for aquafitness, group classes, for aquatraining or functional rehabilitation and athletic training targeted.
- It takes a minimal amount of space out of the water.

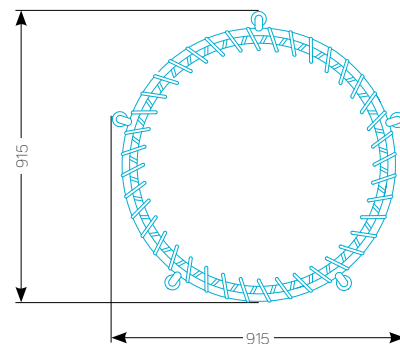
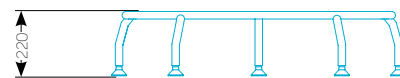

## ROUND JUMP

cod. AFA 0603





Comoda impugnatura in acciaio  
Stainless steel handlebar



3 diverse altezze per  
gli esercizi delle gambe  
3 different heights for  
leg exercises



## WATER UP & DOWN

- + FACILE E VERSATILE  
EASY AND ADAPTABLE
- + DIVERSE ALTEZZE E PIANI DI MOVIMENTO  
SEVERAL HEIGHTS AND MOVEMENT SURFACES
- + INNUMEREVOLI ESERCIZI  
COUNTLESS EXERCICES
- + UTILIZZO IN COPPIA  
USED IN PAIRS
- + ADATTO A QUALSIASI ALLIEVO  
SUITABLE TO ALL LEARNERS







### EAA INSTRUCTOR TRAININGS:

Master **WATER UP & DOWN - ON DEMAND**

Master **AQUA CIRCUIT**

Master **AQUAxFIT®**

Course **AQUA PERSONAL PROGRAM**



Materiale Material	Inox AISI 316L 316L stainless steel
Profondità d'impiego Depth of use	100 - 120 cm
Peso Weight	7 kg

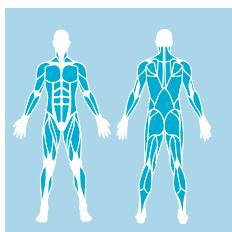

### Articolo prodotto solo su richiesta.

WATER UP & DOWN è un attrezzo acquatico di facile impiego.

La sua versatilità ne consente l'utilizzo per l'aquafitness classica, ma anche in contesti più specifici come rieducazione funzionale, attività per disabili e corsistica per ragazzi.

### Model exclusively on request.

WATER UP & DOWN is a water equipment very easy to use. It can be used for general aquafitness, but also in more specific fields, such as rehabilitation, activities for disabled people and childrens courses.

## WATER UP & DOWN

cod. AFA UPD 001

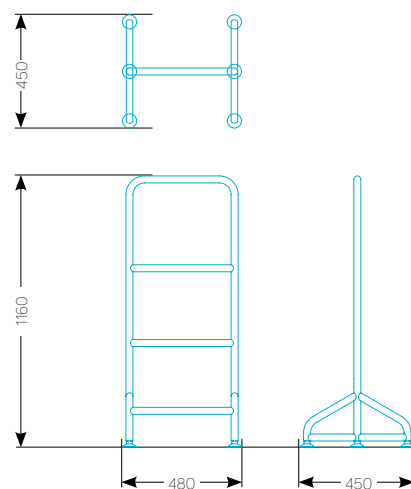

**MOON WALKER  
ROUND JUMP  
WATER UP & DOWN**



BAQ 0001  
**Borraccia**  
Bottle



BAQ 0002  
**Porta Borraccia**  
Bottle Cage



AFA RGEN A03  
**Ventosa blu**  
Blue suction cap



AFO 0300  
**Parabordo**  
Board guard



AFO PEA  
**Pedane in inox**  
Platforms

**Optional**  
Su richiesta | On request

AFA 0150   AFA 0150 N <b>MOON WALKER</b>	-	-	✓	✓	✓
AFA 0603 <b>ROUND JUMP</b>	-	-	✓	-	✓
AFA UPD 001 <b>WATER UP &amp; DOWN</b>	✓	✓	articolo di serie standard article	-	✓



**Dettagli**  
Tecnici | Technical

	Materiale Material	Ingombro minimo Minimum bulk	Profondità d'impiego Depth of use	Peso Weight	Persone Users
AFA 0150   AFA 0150 N <b>MOON WALKER</b>	Inox AISI 316L Stainless steel 316L	820 x 1100 mm	100 - 140 cm	26 kg	1
AFA 0603 <b>ROUND JUMP</b>	Inox AISI 316L Stainless steel 316L	915 x 915 mm	100 - 140 cm	5 kg	1
AFA UPD 001 <b>WATER UP &amp; DOWN</b>	Inox AISI 316L Stainless steel 316L	480 x 450 mm	100 - 120 cm	7 kg	2

FLOAT2FITNESS



**4 STAZIONI ANGOLARI** esterne per una massima differenziazione  
4 external CORNER STATIONS for maximum differentiation



**T-BAR**  
Stazione di allenamento braccia e dorsali con barra trazioni  
T-BAR arm and back training station with pull-up bar



**STAZIONE SINGOLA**  
altezza regolabile per aggancio di un elastico  
SINGLE STATION with adjustable height for hooking on one resistance band



## FLOAT2FITNESS

- + EXCLUSIVE DESIGN MADE IN ITALY
- + ATTREZZO POLIVALENTE  
MULTI-PURPOSE EQUIPMENT
- + SOLUZIONE MODULARE  
MODULAR SOLUTION
- + PALESTRA GALLEGGIANTE  
FLOATING GYM
- + UTILIZZO SIMULTANEO FINO A 8 PERSONE  
MULTIPLE USE FOR UP TO 8 PEOPLE
- + CIRCUIT TRAINING, RECUPERO FUNZIONALE E PREPARAZIONE ATLETICA  
CIRCUIT TRAINING, FUNCTIONAL RECOVERY AND ATHLETIC PREPARATION
- + NUOVI ACCESSORI  
NEW ACCESSORIES

**SEDILE** con altezza regolabile per modulare correttamente la posizione in acqua  
SEAT with adjustable height to correctly modulate the position in water



**STAZIONE** con altezza regolabile e possibilità di aggancio di 6 elastici  
STATION with adjustable height and 6 rings for hooking on resistance bands

Optional

Su richiesta | On request

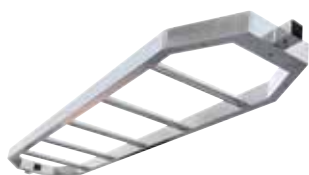

AFA FLO 0002

**SCALA ORIZZONTALE** necessaria per l'unione di 2 Float2Fitness  
**HORIZONTAL LADDER** necessary for connecting 2 Float2Fitness

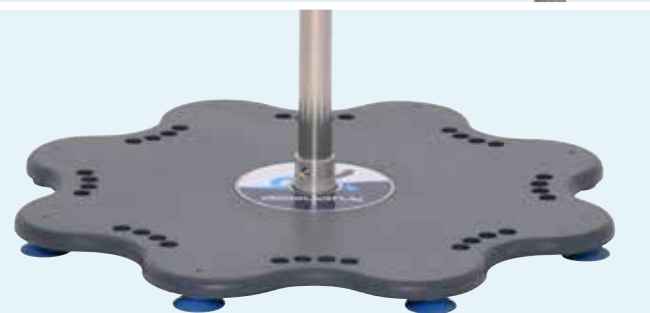

**BASE** in pvc con asta verticale prodotta su misura in base alla profondità della vasca  
PVC BASE with a vertical rod custom made according to the depth of the pool

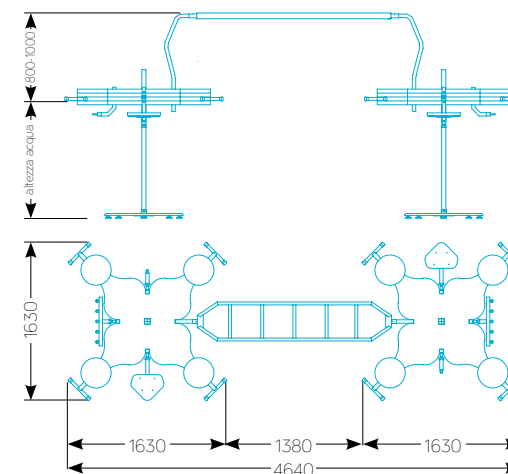



**EAA**  
EUROPEAN AQUATIC ASSOCIATION

**EAA INSTRUCTOR TRAINING:**  
ON DEMAND F2F Training Method



**Materiale**  
Material

Eva 100 + Pvc + Inox  
AISI 316L stainless st.

**Profondità d'impiego**  
Depth of use

> 110 cm

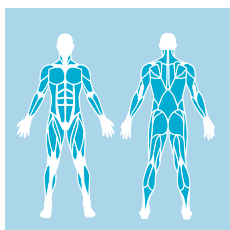
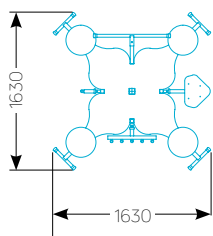
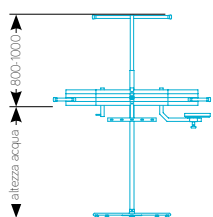

Attrezzo innovativo e modulare, FLOAT2FITNESS è una palestra galleggiante che porta il concetto del fitness in acqua a un livello superiore. Con possibilità di creare percorsi di allenamento funzionale in modo facile, rapido e divertente, F2F è stata sviluppata per soddisfare non solo il pubblico del fitness acquatico, ma anche quello sportivo e riabilitativo, grazie all'abbinamento di attrezzi e accessori intercambiabili a beneficio della qualità dell'esercizio effettuato. Ciascun modulo F2F è quindi fruibile da 8 persone contemporaneamente. Agganciando tra loro due moduli, con accessorio opzionale - Scala Orizzontale - è possibile creare un circuito dalle dimensioni e potenzialità maggiori.

**Il modulo base di FLOAT2FITNESS dispone di:**

- 1 asta con base di ancoraggio al fondo
- 1 seduta per workout gambe e addome
- 1 attacco per elastici mono posizione
- 1 attacco per elastici a 6 posizioni
- 1 Kit Accessori
- 1 T-bar per trazioni delle braccia
- 4 stazioni angolari esterne per un core training dinamico e divertente.

The basic FLOAT2FITNESS module has:

- 1 rod with anchoring base at the bottom
- 1 seating support for leg and abdomen workout
- 1 attachment for single position elastics
- 1 attachment for 6-position elastics
- 1 Accessory Kit
- 1 T-bar for arm pulls
- 4 external corner stations for dynamic and fun core training.



**KIT ACCESSORI**

- 2 maniglie in neoprene
- 1 cavagliera con chiusura velcro
- 2 elastici STRONG + 2 moschettoni
- 2 elastici MEDIUM + 2 moschettoni
- 1 Cintura

**ACCESSORY KIT**

- 2 neoprene handles
- 1 anklet with velcro straps
- 2 STRONG elastic bands + 2 karabiners
- 2 MEDIUM elastics + 2 karabiners
- 1 Belt

**Colori: soggetti a disponibilità di magazzino**  
Colours: subject to availability

An innovative and modular device, FLOAT2FITNESS is a floating gym that takes the concept of fitness in the water to a new level. With the possibility of creating functional training courses in an easy, quick and fun way, F2F has been developed to satisfy not only the aquatic fitness public, but also those focused on sports and rehabilitation, thanks to a combination of interchangeable tools and accessories that enhance the quality of the exercise being carried out. Each F2F module can be used by 8 people simultaneously. By hooking two modules together, using an optional accessory - Horizontal Ladder - a circuit with greater dimensions and potential can be created.

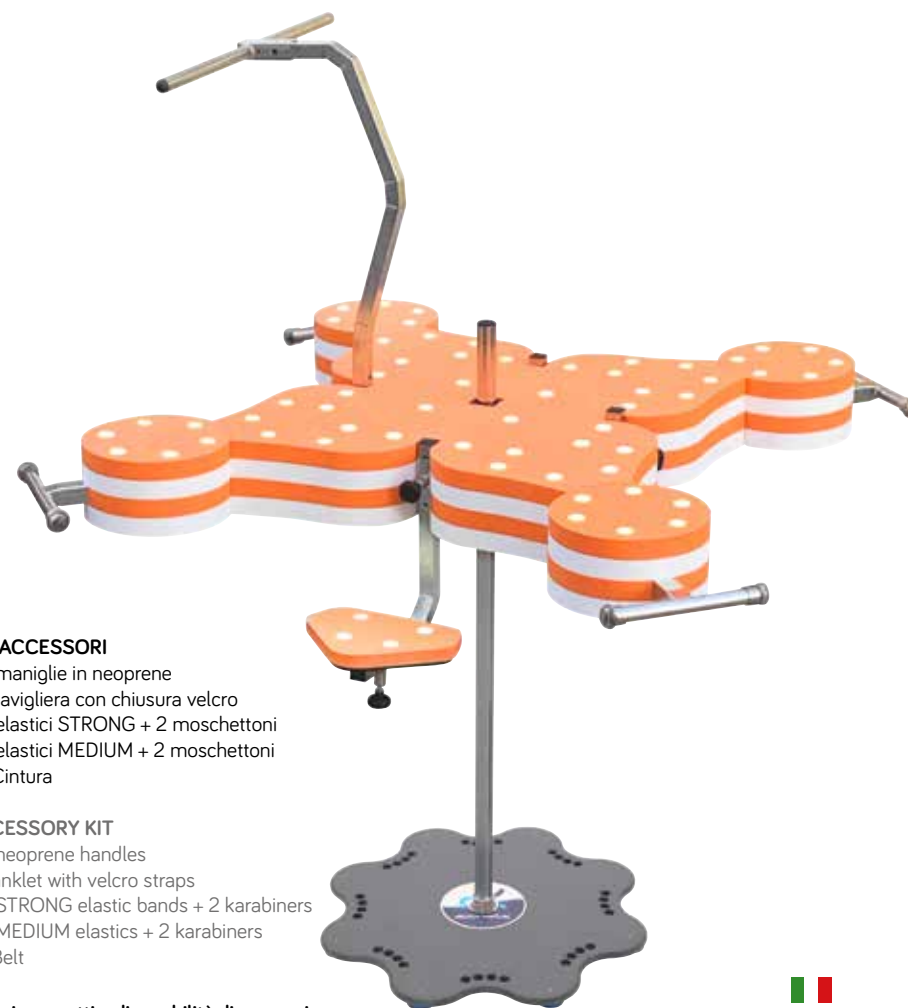

**FLOAT2FITNESS**  
cod. AFA FLO 0001





## VERTICAL DYNAMIC



- + EXCLUSIVE DESIGN, MADE IN ITALY
- + STABILE IN ACQUA E MANEGGEVOLE FUORI  
STABLE IN WATER AND OUTSIDE
- + SISTEMA INNESTO RAPIDO  
QUICK COUPLING SYSTEM
- + NUOVO KIT ELASTICI  
NEW ELASTICS KIT
- + NUOVA COMBAT BAG  
NEW COMBAT BAG
- + VENTOSE EXTRA TENUTA  
EXTRA STRONG SUCTION CUPS

L'anello permette di regolare il livello del sacco in funzione dell'altezza dell'acqua e della persona, rendendo il suo utilizzo estremamente funzionale

The ring allows to adjust the level of the bag according to the height of water and person, making it extremely functional



Design studiato con appositi fori per agevolare la movimentazione fuori dall'acqua

Studied in detail with special holes to facilitate handling out of the water

## VERTICAL DYNAMIC

Optional  
Su richiesta | On request



AFA VD 100  
**VD COMBAT BAG**  
1 Combat Bag + 1 anello forato  
1 Combat Bag + 1 ring



AFA VD 101  
**VD TRAINING KIT**  
2 elastici MEDIUM + 2 moschettoni  
1 elastico STRONG + 2 moschettoni  
2 maniglie + 1 cavigliera + 2 anelli forati  
2 elastic MEDIUM bands + 2 karabiners  
1 elastic STRONG band + 2 karabiners  
2 handles + 1 ankle cuff + 2 rings

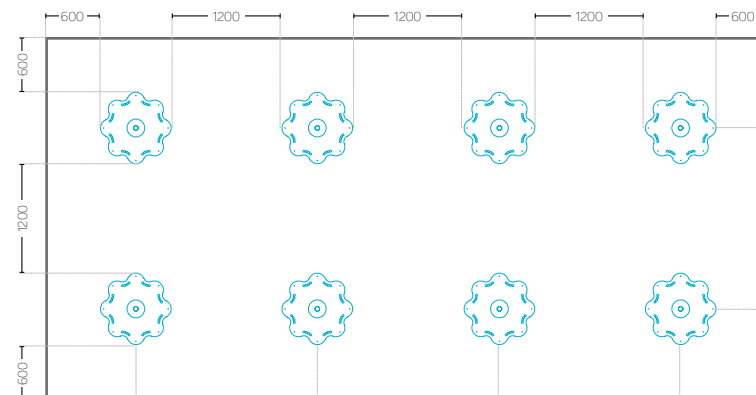

AFA VD 001.200 <b>VERTICAL DYNAMIC 200 cm</b>	✓	✓
AFA VD 001.250 <b>VERTICAL DYNAMIC 250 cm</b>	✓	✓



**EAA INSTRUCTOR TRAINING:**  
Master **AQUA VERTICAL DYNAMIC**



**Materiale**  
Material

Base: PVC  
Palo: AISI 316L  
Base: PVC  
Pole: AISI 316L

**Profondità d'impiego**  
Depth of use

**200** 100 - 170 cm  
**250** > 170 cm

**Peso**  
Weight

**200** 21 kg  
**250** 24 kg

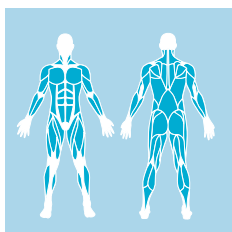
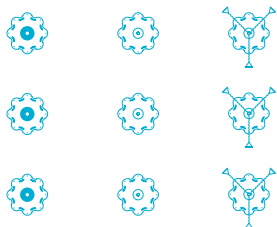

VERTICAL DYNAMIC, nella sua semplicità, rappresenta un punto fermo nelle dotazioni di attrezzi di una vasca.

- Facile movimentazione, gradevolezza del design e ottima stabilità della base in Pvc, dotata di 8 ventose ad alta aderenza.
- Sistema d'innesto dell'asta facile e sicuro, tutto in acciaio inox AISI 316L, garantisce la massima qualità e sicurezza.

La versatilità dell'attrezzo è garantita da:

- un innovativo COMBAT BAG studiato per essere facilmente utilizzabile sia con le braccia che con le gambe, dotato di cerniera per agevolare le operazioni di manutenzione del prodotto;
- possibilità di aggiunta di elastici con maniglie e con cavigliera per garantirne l'utilizzo simultaneo a più persone.

VERTICAL DYNAMIC, with its simplicity, is a must have in every pool's equipment.

- Easy to handle, with a pleasant design and excellent stability of its PVC base, equipped with 8 high-grip suction cups.
- Its simple and safe quick coupling system, made in 316L stainless steel, guarantees maximum quality and safety.

The versatility of the equipment is guaranteed by:

- an innovative COMBAT BAG designed to be easily used with both arms and legs, equipped with a hinge to facilitate the product maintenance operations;
- possibility of adding elastic bands with handles and ankle cuff to guarantee simultaneous use for up to more people.

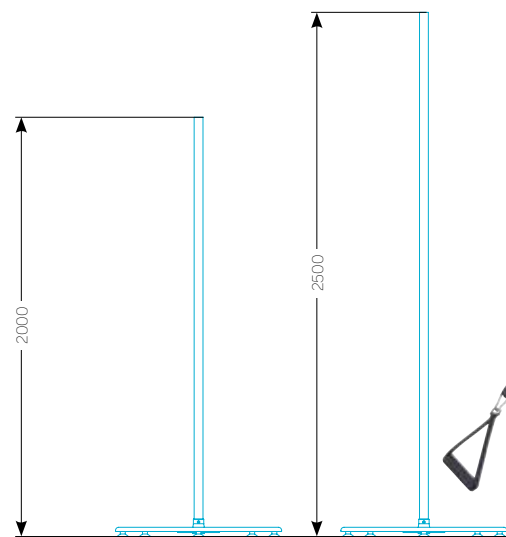

cod. AFA VD 001200  
mod. 200 cm

cod. AFA VD 001250  
mod. 250 cm

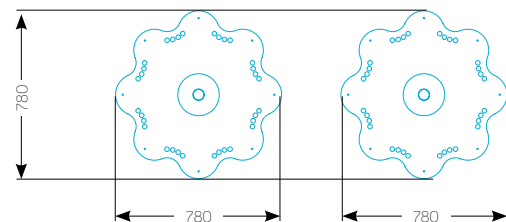

**VERTICAL DYNAMIC**  
cod. AFA VD 001.200 mod. 200 cm  
cod. AFA VD 001.250 mod. 250 cm





## AQUA FITNESS BOARD

- + VERSATILITÀ DI UTILIZZO  
VERSATILE USE
- + 4 PUNTI DI ANCORAGGIO  
4 POINTS OF TETHERING
- + AMPIA SUPERFICIE CON TEXTURE ANTISCIVOLO  
LONG, TEXTURED NON-SLIP DECK
- + PRATICO PORTA OGGETTI ELASTICO  
CONVENIENT BUNGEE POCKET
- + COMODE MANIGLIE IN NEOPRENE  
COMFORTABLE NEOPRENE HANDLES
- + FACILE DA TRASPORTARE  
EASILY TO TRANSPORT
- + MATERIALE EXTRARESISTENTE, PVC A DOPPIO STRATO  
EXTRA DURABLE, DOUBLE LAYER OF PVC



Punto di ancoraggio  
Point of tethering

Superficie anti scivolo  
Non-slip deck

Comode maniglie in neoprene  
Comfortable neoprene handles

Aqua Fitness Board è prodotto  
con materiali d'alta qualità  
Aqua Fitness Board is produced  
using high quality materials

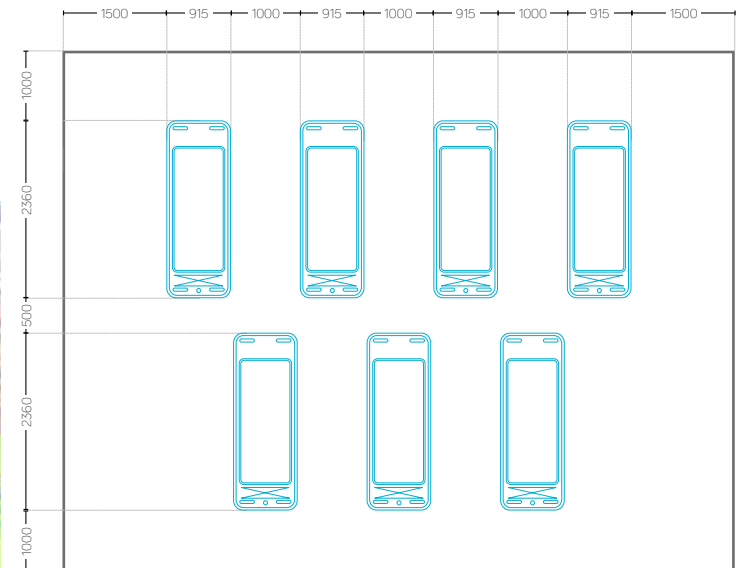

## AQUA FITNESS BOARD



AFA 0400  
Elastici  
Elastics



AFB 0512  
Bande Elastiche  
Elastic bands



Optional  
Su richiesta | On request

MAT ABS 001  
AQUA FITNESS BOARD







**EAA**  
EUROPEAN AQUATIC ASSOCIATION

### EAA INSTRUCTOR TRAINING:

Master **AQUA BOARD**



**Materiale**  
Material

PVC + Eva +  
Acciaio AISI 316  
Stainless steel AISI  
316

**Profondità d'impiego**  
Depth of use

min. 120 cm

**Dimensioni**  
Dimensions

236 x 91,5 x 15 cm

**Punti di ancoraggio**  
Points of tethering

4

**Peso (solo materassino)**  
Weight (only the board)

9 kg

**Pressione consigliata**  
Recommended  
pressure

7 PSI  
0,48 bar

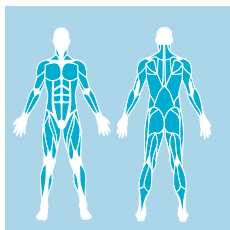

AQUA FITNESS BOARD è la soluzione perfetta per proporre lezioni di fitness innovative, divertenti e complete.

- Leggera e gonfiabile, è pensata per ogni contesto acquatico con possibilità di ancoraggio.
- Prodotta con materiali di qualità, AFB è estremamente durevole e garantisce stabilità e sicurezza grazie ai 4 punti di ancoraggio e l'innovativa superficie anti-scivolo.

AQUA FITNESS BOARD is the perfect platform to offer innovative, funny and complete fitness classes.

- Light-weight and inflatable, AFB is designed for all aquatic context with the possibility of anchoring.
- AFB is produced with high quality and durable materials to ensure superior safety and stability, featuring 4 points of tethering and the innovative textured, non-slip deck.

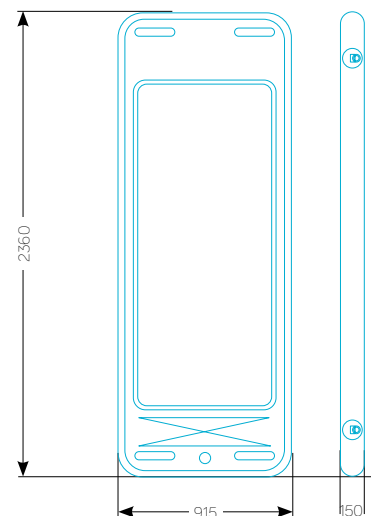

## AQUA FITNESS BOARD

cod. MAT ABS 001



### KIT ANCORAGGIO

4 elastici con moschettoni in acciaio  
**TETHERING BUNGEEES**  
4 bungees with stainless steel karabiker



### POMPA MANUALE

1 ogni 10 board  
**HAND PUMP**  
1 every 10 boards



### KIT RIPARAZIONE:

colla e 2 pezzi  
**REPAIR KIT:**  
glue e 2 patches



Superficie antiscivolo del Pad  
Non-slip surface Pad



Pinna sotto la tavola  
Bottom fin

Pagaia in alluminio, con lunghezza regolabile  
Aluminium paddle with adjustable length



## SUP STAND UP PADDLE

- + 3 DIMENSIONI PER ACQUE LIBERE  
3 SIZES FOR OPEN WATER
- + QUALITÀ DEI MATERIALI  
HIGH-QUALITY MATERIALS
- + VERSATILITÀ DI UTILIZZO  
VERSATILE USE
- + ALLENAMENTO DI TUTTO IL CORPO  
SPECIFIC TRAINING FOR BODY CONTROL
- + SUPERFICIE ANTISCIVOLO  
NON-SLIP SURFACE



Valvola con chiusura di sicurezza  
Valve with safety device

### Optional

Su richiesta | On request



SUP R000 CRB  
Pagaia in carbonio  
Carbon paddle

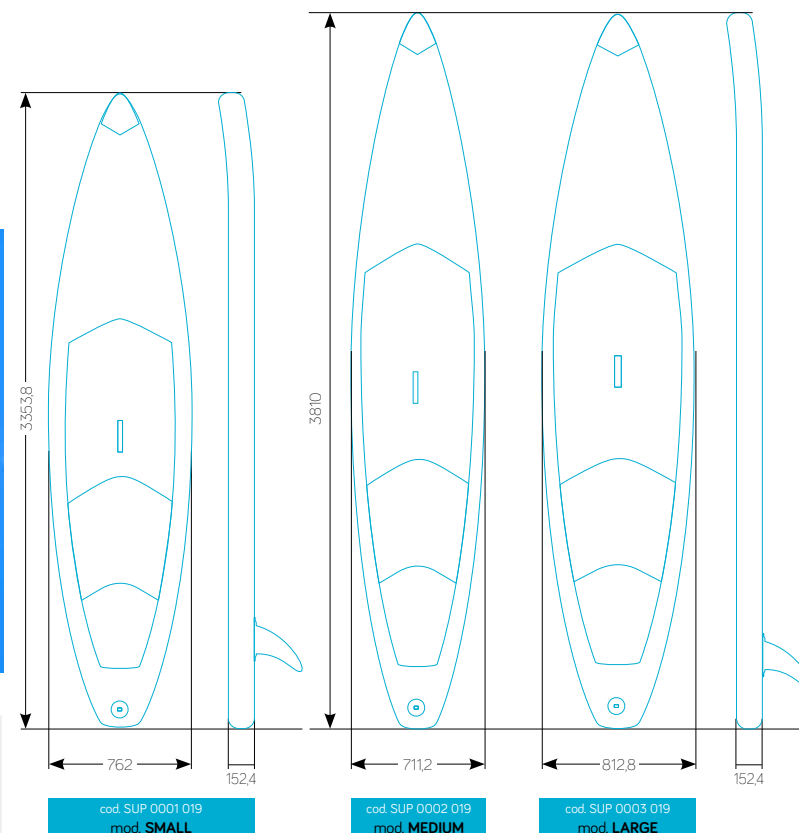

## SUP STANDARD KIT

- SUP 0001 019 **SMALL SUP**
- SUP 0002 019 **MEDIUM SUP**
- SUP 0003 019 **LARGE SUP**

1 Tavola  
1 Board

SUP R000 ALM  
Pagaia in alluminio  
Aluminum paddle

SUP RPMP 001  
Pompa manuale  
Hand pump

SUP RBRS 001  
Borsa  
Bag

SUP RKRP 001  
Kit riparazione  
Repair kit



<b>Materiale</b> Material	PVC + Eva + Acciaio AISI 316
<b>Profondità d'impiego</b> Depth of use	acque libere
<b>Lunghezza pagaia</b> Paddle length	regolabile adjustable
<b>Peso</b> Weight	<b>SMALL</b> 11,2 kg <b>MEDIUM</b> 12 kg <b>LARGE</b> 13,8 kg
<b>Pressione consigliata</b> Recommended pressure	14 - 18 PSI 0,97 - 1,24 bar

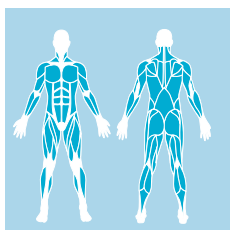

Tavole gonfiabili, indicate per praticare il SUP in acque libere, ovvero *Stand up Paddle*: attività semplice e divertente, accessibile a tutti, senza limiti di età e forma fisica.

Il gioco stabilità/instabilità, unito all'utilizzo della pagaia, garantisce un valido mezzo di allenamento per tutto il corpo.

Le tavole sono disponibili in 3 dimensioni, ordinabili in base alla tipologia di utente: **principiante, praticante, esperto**

**SUP 0001 019 SMALL BOARD**  
11' x 30" x 6" (335,28 x 76,20 x 15,24 cm)

Tavola per **principianti** (bambini e adulti): soluzione più pratica, indicata per percorsi brevi.

**SUP 0002 019 MEDIUM BOARD**  
12'6" x 28" x 6" (381,00 x 71,12 x 15,24 cm)

Tavola per **esperti** (ragazzi e adulti): soluzione più performante, indicata per lunghi tragitti.

**SUP 0003 019 LARGE BOARD**  
12'6" x 32" x 6" (381,00 x 81,28 x 15,24 cm)

Tavola per **praticanti** (ragazzi e adulti): soluzione performante, indicata per lunghi tragitti, ma adatta a chi cerca più stabilità o per persone "oversize".

Inflatable boards, suitable for practising SUP (Stand Up Paddle) in open water: a simple and fun activity, accessible to everyone, regardless of age or physical limits.

SUP is a complete workout that improves athletic ability and balance by effectively working all muscle areas.

The boards are available in 3 sizes, which can be categorised based on the type of user: **beginner, experienced, expert**

**SUP 0001 019 SMALL BOARD**  
11' x 30" x 6" (335.28 x 76.20 x 15.24 cm)

Board for **beginners** (children and adults): a more practical solution, suitable for shorter routes.

**SUP 0002 019 MEDIUM BOARD**  
12'6" x 28" x 6" (381.00 x 71.12 x 15.24 cm)

Board for **expert** users (kids and adults): a more performing solution, suitable for longer itineraries.

**SUP 0003 019 LARGE BOARD**  
12'6" x 32" x 6" (381.00 x 81.28 x 15.24 cm)

Table for **experienced** users (children and adults): a performing solution, suitable for longer journeys, but also suitable for those seeking more stability and for larger users.



## SUP

### STAND UP PADDLE

cod. SUP 0001 019 **SMALL**  
cod. SUP 0002 019 **MEDIUM**  
cod. SUP 0003 019 **LARGE**



## PUZZLE STEP

- + STEP MADE IN ITALY
- + EXCLUSIVE ITALIAN DESIGN
- + PRODOTTO BREVETTATO  
PATENTED PRODUCT
- + 6 VENTOSE PER ADERENZA AL FONDO  
6 STRONG SUCTION CUPS
- + INGOMBRI RIDOTTI  
REDUCED DIMENSIONS
- + 10 FORI PER ASSEMBLAGGIO PIÙ PEZZI  
10 HOLES TO ASSEMBLY MORE PIECES
- + FORNITO CON 2 PESETTI  
SUPPLIED WITH 2 WEIGHTS

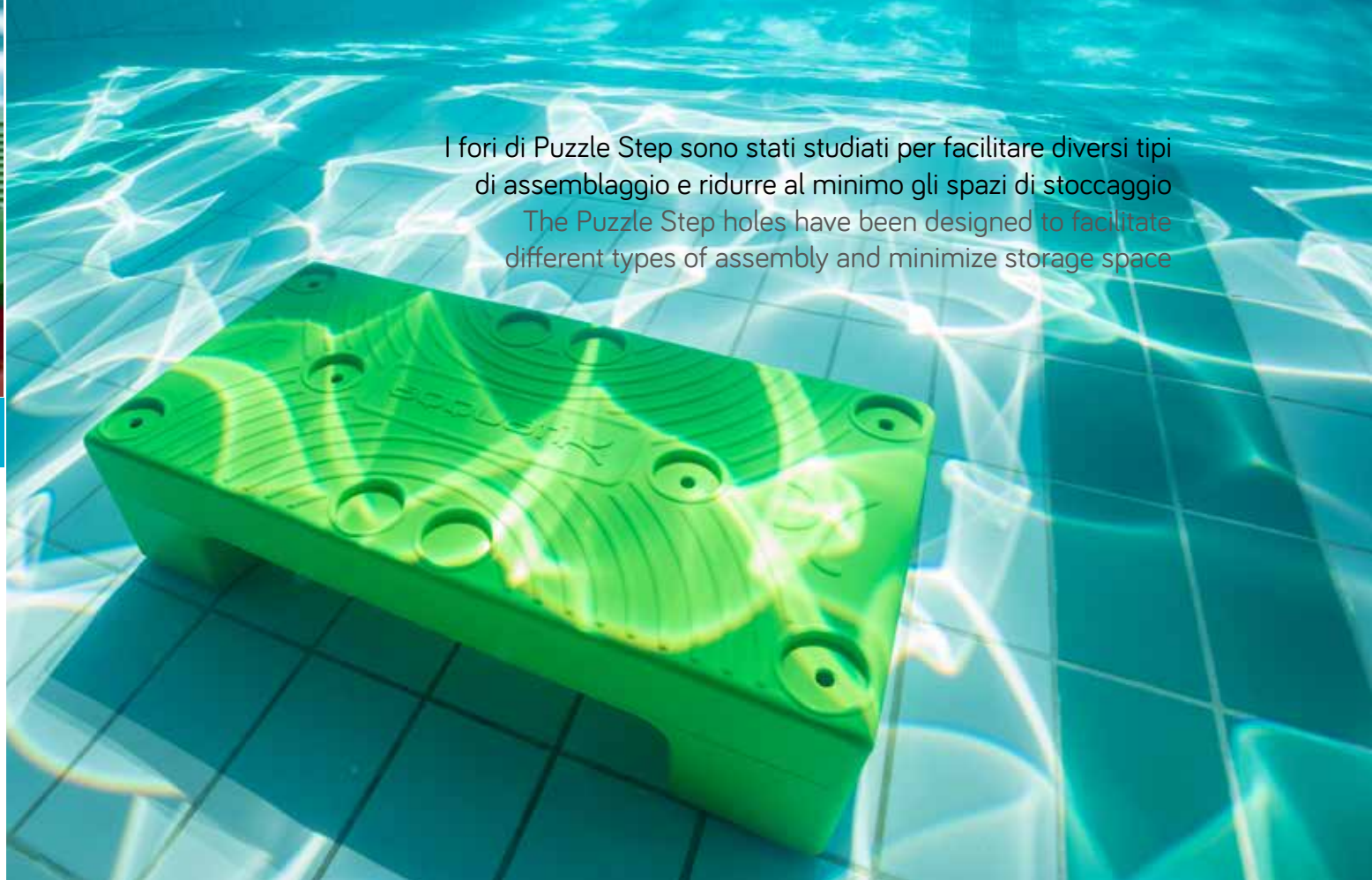

I fori di Puzzle Step sono stati studiati per facilitare diversi tipi di assemblaggio e ridurre al minimo gli spazi di stoccaggio  
The Puzzle Step holes have been designed to facilitate different types of assembly and minimize storage space



Puzzle Step in fase di stoccaggio  
Puzzle Step storage



Si possono creare piattaforme per attività ludo-didattiche coi bambini...  
You can create platforms for play and pedagogical activities with children...

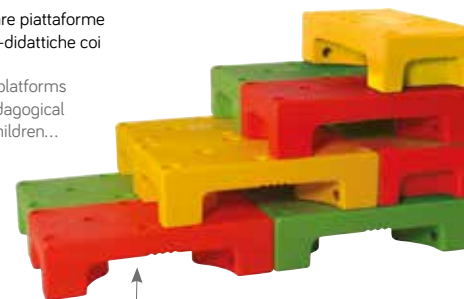

...oppure comode scalette per facilitare l'accesso o l'uscita dall'acqua  
...or comfortable ladders to facilitate entering and leaving the water

Orange

Yellow

min. | moq. 10 pz  
consegna | delivery 60 gg.

Lime  
NEW COLOUR

Green



### EAA INSTRUCTOR TRAININGS:

Master **AQUA STEP & JUMP**

Master **AQUA CIRCUIT**

Master **AQUAxFIT®**

Course **AQUA PERSONAL PROGRAM**



**Materiale**  
Material

Polietilene  
Polyethylene

**Profondità d'impiego**  
Depth of use

120 - 140 cm

**Peso**  
Weight

6 kg

**Dimensioni**  
Dimensions

70 x 35 x h 19 cm

### QUALI VENTOSE SCEGLIERE? WHICH KIND OF SUCTION CUP?



**AFA RGEN 003**  
consigliata per vasche con **SUPERFICI LISCE** (pvc liscio, ceramica liscia...) suggested for **SMOOTH SURFACE** pools (smooth pvc, smooth ceramic...)



**AFA RGEN A03**  
consigliata per vasche con **SUPERFICI SEMI RUVIDE O IRREGOLARI** (mosaico, inox bugnato, ceramica ruvida, pvc ruvido...) suggested for **UNEVEN OR IRREGULAR SURFACE** pools (mosaic, embossed stainless steel, rough ceramic ruvida, rough pvc...)

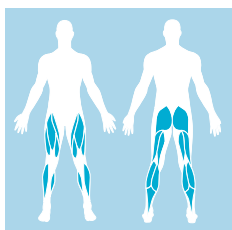

Il PUZZLE è uno STEP modulare, unico al mondo.

- Progettato dal centro R&D di Aquatix.
- La sua originalità, oltre a forma e dimensioni, sta nella realizzazione di fori sulla superficie di appoggio che garantiscono stabilità anche in caso di più attrezzi sovrapposti.

PUZZLE STEP, is a modular step, one of a kind.

- Designed and developed by the Aquatix R&D Centre.
- Its original design, in addition to the shape and dimensions, is evident from the holes on the surface, which ensure stability even in case of overlapped Steps.



cod. AFT 0018 B

### PUZZLE STEP CON VENTOSE BLU

Ventose utili per vasche con fondo a mosaico.

Attenzione: in questo modo gli step non sono impilabili.

Blue suction cups recommended for mosaic floor.

Please note: the steps in this case are not stackable.

### PUZZLE STEP

cod. AFT 0018

mod. **STANDARD**

cod. AFT 0018 B

mod. **VENTOSE BLU**

mod. **BLUE SUCTION CUPS**





3 Moon Bite Step formano 1 Acqua Circle Step  
Three Moon Bite Steps constitute an Acqua Circle Step

## MOON BITE STEP

- + STEP MADE IN ITALY
- + EXCLUSIVE ITALIAN DESIGN
- + 8 VENTOSE PER ADERENZA AL FONDO  
8 STRONG SUCTION CUPS
- + ESCLUSIVA FORMA SEMICIRCOLARE  
ESCLUSIVE DESIGNED TO FORM A 1/3 CIRCLE
- + DUE PERSONE PER STEP  
TWO PERSONS PER STEP.
- + 3 STEP FORMANO UN CERCHIO  
3 STEPS CONSTITUTE A CIRCLE



L'esclusiva forma di Moon Bite Step è unica al mondo e permette di creare un grande step circolare, ma anche diversi percorsi alternativi

The exclusive shape of Moon Bite Step is unique in the world and allows you to create a large circular step but also different alternative routes





### EAA INSTRUCTOR TRAININGS:

Master **AQUA STEP & JUMP**

Master **AQUA CIRCUIT**

Master **AQUAxFIT®**

Course **AQUA PERSONAL PROGRAM**



**Materiale**  
Material

Polietilene  
Polyethylene

**Profondità d'impiego**  
Depth of use

120 cm

**Peso**  
Weight

AFT 0014 10 kg  
AFT 0015 30 kg

**Dimensioni**  
Dimensions

AFT 0014 120 x h 20 cm  
AFT 0015 160 x h 20 cm

### QUALI VENTOSE SCEGLIERE? WHICH KIND OF SUCTION CUP?



**AFA RGEN 003**  
consigliata per vasche con **SUPERFICI LISCE** (pvc liscio, ceramica liscia...) suggested for **SMOOTH SURFACE** pools (smooth pvc, smooth ceramic...)



**AFA RGEN A03**  
consigliata per vasche con **SUPERFICI SEMI RUVIDE O IRREGOLARI** (mosaico, inox bugnato, ceramica ruvida, pvc ruvido...) suggested for **UNEVEN OR IRREGULAR SURFACE** pools (mosaic, embossed stainless steel, rough ceramic ruvida, rough pvc...)

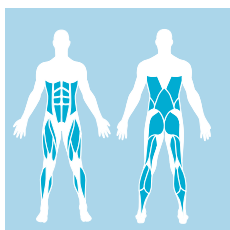

### Modello solo su richiesta: minimo quantitativo 50 pezzi.

Step modulare, unico al mondo: progettato dal centro R&D di Aqqatix. La sua originalità sta nella forma e nelle dimensioni:

- è realizzato per essere pari ad 1/3 di cerchio ("un morso di luna")
- consente l'utilizzo a due persone contemporaneamente.
- la forma semicircolare permette di creare percorsi alternativi.

### Model exclusively on request: minimum quantity of 50 pieces.

Modular step, one of a kind, patented: designed and developed by the Aqqatix R&D Centre.

Its original design is evident from the shape and dimensions.

- It's designed to form a 1/3 circle (the "moon bite")
- It can be used by two persons simultaneously.
- The semicircular shape allow to create different circuit.



## MOON BITE STEP

cod. AFT 0014



### Modello solo su richiesta: minimo quantitativo 50 pezzi.

Tre Moon Bite Step uniti formano un grande step circolare, che consente di coinvolgere fino a 6-8 persone contemporaneamente.

Rivoluzionaria attività in acqua:

- aqua circuit
- didattica
- divertimento.

### Model exclusively on request: minimum quantity of 50 pieces.

Three Moon Bite Step joined together constitute a large circular step that can involve up to 6-8 people at the same time.

Not only for aqua fitness:

- aqua circuit
- learning
- fun.



## AQUA CIRCLE STEP

cod. AFT 0015





**aqquatix**<sup>®</sup>  
equipment for very aqquatix people

**AQQUATIX SRL**  
Limena (Padova)  
ITALY  
T. +39 049 738 11 50

**[www.aqquatix.com](http://www.aqquatix.com)**  
Italy: [info@aqquatix.com](mailto:info@aqquatix.com)  
Export: [export@aqquatix.com](mailto:export@aqquatix.com)

Training by EAA  
[www.euroaquatic.it](http://www.euroaquatic.it)



Release: 2019, november

# aquatic<sup>®</sup>

equipment for very aquatic people

AQUAFITNESS TREND

AQUAFITNESS BASIC

AQUAWELLNESS

AQUAREHAB



**EAA**  
EUROPEAN AQUATIC ASSOCIATION

# Index

## Aquafitness Trend

- 4 **SUPERIOR BELT + CLOUD FOOT**
- 5 **HAPPY FLOWER + AQUACOMBAT GLOVES**
- 6 **ACQUAFLY + AQUARAFT**
- 7 **WAVES + HANDFINS 300**
- 8 **CUFFS**
- 9 **MAGIC AQUABALL + EXTRA GLOVES**

## Aquafitness Basic

- 10 **AQUABELT + RESISTENCE BAND + ACTIVE TUBE**
- 11 **EASY COMBAT GLOVES + AQUAGLOVES +**
- 11 **AQUABELLS + AQUAWRISTES**

## Aqwellness Aquilibrium

- 12 **AQUUNIVERSAL RINGS + NEKDOODLE**
- 13 **AQUATUBE**
- 14 **AQUAPANTS**
- 15 **CESSI**
- 16 **ACQUAMI®**

## Aquarehab

- 18 **SINGLE REHAB PADDLE + AQUA BALANCE BOARD +**
- 18 **LEG&ARM PADDLE**

## Icons



**CORSI DI FORMAZIONE\***  
TRAINING COURSES\*

**CARATTERISTICHE TECNICHE**  
TECHNICAL FEATURES

**CONSUMO CALORICO**  
BURNED CALORIES



\* Tutti i prodotti Aqqatix sono raccomandati da EAA

\* All Aqqatix products are recommended by EAA  
[www.euroaquatic.it](http://www.euroaquatic.it)

AQUAFITNESS  
TREND



## SUPERIOR BELT

cod. AFB 0008 mod. **MEDIUM**

cod. AFB 0009 mod. **LARGE**



Design unico e originale, studiato per garantire massima aderenza alla vita e il migliore comfort durante l'utilizzo. Realizzata con lavorazione a stampo con ottimo sistema avvolgente della cintura in tessuto, caratterizzato da elementi che assicurano una regolazione fine e sfruttano l'elasticità del materiale galleggiante. Il materiale è altamente durevole, facilmente igienizzabile e certificato CE.

Unique and original design to ensure maximum support at the waist, for stability and maximum comfort during use. Moulded design: the brand new fabric closure system features two separate components that ensure fine adjustment and take advantage of the elasticity of the floating material. The material is highly durable, disinfected and CE certified.



<b>Materiale</b> Material	Eva Foam injected Eva
<b>Prof. d'impiego</b> Depth of use	tutte le prof. d'impiego any depths
<b>Dimensioni</b> Dimensions	<b>AFB 0008</b> 78,5 x 27,5 x 4 cm <b>AFB 0009</b> 93 x 27,5 x 4 cm

### Ricambi | Spare parts

**AFB 0101** 65 cm > AFB 0008  
coppia di fettucce di ricambio tg. M  
replacement band M (pair)

**AFB 0102** 74 cm > AFB 0009  
coppia di fettucce di ricambio tg. L  
replacement band L (pair)

**AQU 0201**  
chiusura a clip (maschio/femmina)  
buckle (male/female)

**AFB 0010**  
coppia di elementi aggiuntivi per tg. L  
pair of L size elements



## CLOUD FOOT

cod. AFT 0035



Coppia di attrezzi adatti al fitness e alla riabilitazione in acqua fonda. L'allenamento è molto divertente e esercita diversi gruppi muscolari, grazie anche alla variazione di spessore della "suola". La scarpetta è stata studiata per garantire il comfort del piede durante l'utilizzo. Il morbido foam di cui è fatta, si adagia sul collo del piede, evitando fastidiosi sfregamenti delle cinghie sulla pelle.

Pair of tools suitable to fitness and rehabilitation in deep water. The workout is very entertaining and exercising different muscle groups, thanks also to the variation in thickness of the "sole". The shoe is designed to ensure the comfort of the foot during use. The soft foam of the Cloud Foot, closed on the instep, avoid the rubbing of belts on the skin.



<b>Materiale</b> Material	Eva Foam injected Eva
<b>Dimensioni</b> Dimensions	35 x 18 x 15 cm
<b>Profondità d'impiego</b> Depth of use	tutte le prof. d'impiego any depths

### Ricambi | Spare parts

**AFT 0212**  
fettuccia di ricambio con velcro  
replacement belt with velcro





**Materiale**  
Material

Eva Foam  
injected Eva

**Dimensioni**  
Dimensions

**AFT 0001** ø 26 cm  
**AFT 0001.1** ø 31,5 cm

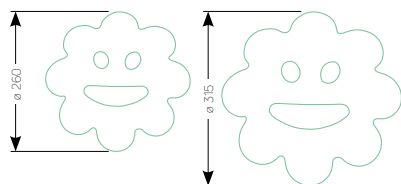

**EAA INSTRUCTOR TRAININGS:**

Course **AQUA FITNESS** - First  
Course **AQUA FITNESS** - Advanced  
Master **AQUA CIRCUIT**  
Master **AQUAxFIT**  
Course **AQUA PERSONAL PROGRAM**

Coppia di attrezzi di tendenza, ottimali per un esercizio completo degli arti superiori. Unici ed esclusivi per morbidezza del materiale e per l'azione a resistenza variabile determinata dai petali "attivi".

Trendy pair of excellent tools for a complete upper limbs training. Unique and exclusive for the softness of its material and for the variable resistance due to its "active" petals.



## HAPPY FLOWER

cod. AFT 0001  
cod. AFT 0001.1 mod. **GIANT**



**Materiale**  
Material

Eva Foam  
injected Eva

**Colori**  
Colours

2 colori disponibili  
2 available colours



**EAA INSTRUCTOR TRAININGS:**

Course **AQUA FITNESS** - First  
Course **AQUA FITNESS** - Advanced  
Master **AQUA CIRCUIT**  
Master **AQUAxFIT**  
Course **AQUA PERSONAL PROGRAM**

Coppia di guantoni per il lavoro intenso degli arti superiori. Impugnatura morbida con ottima presa ed efficacia di azione. Unico nel suo genere ed efficace nelle attività di aquacombat.

Pair of gloves for aqua combat activities, they allow hard work for upper limbs. Soft and excellent hand grip, its shape makes very effective the workout in the water.



## AQUACOMBAT GLOVES

cod. AFT 0022

## ACQUAFly

cod. AFT 0036



AcquaFly può essere impugnato immergendo il corpo in acqua fino alle spalle, afferrando la maniglia centrale con la mano che si trova immersa in acqua, sotto l'attrezzo. Questo modo di afferrare l'attrezzo permette di effettuare infiniti esercizi in totale scarico gravitazionale, con un livello di difficoltà molto più basso in quanto tutto il corpo è immerso in acqua; ciò consente di praticare AcquaFly anche alle persone meno esperte, meno forti, in sovrappeso, con problemi alla colonna vertebrale o impossibilitate a far uso della parte superiore del corpo.

AcquaFly can be held by immersing the body in water up to the shoulders, grabbing the central handle with the hand that is immersed in water. This way of grabbing the tool allows you to perform infinite exercises in total gravity discharge, with a much lower level of difficulty as the whole body is immersed in water; this allows AcquaFly to be used even by those who are less experienced, less strong, overweight, with spinal problems or unable to use the upper part of the body.



## AQUARaft

cod. AFT 0021



Con AquaRaft si possono eseguire diversi esercizi di potenziamento muscolare e allenare tutto il corpo. È dotato di varie maniglie che permettono di tenere il prodotto in diversi modi, sia orizzontalmente che verticalmente. Ciò consente di allenare efficacemente la parte superiore del corpo, ma può essere utilizzato anche per allenare la parte inferiore del corpo. AquaRaft offre anche l'opportunità di lavorare in coppia.

With AquaRaft you can perform different exercises to strengthen muscles and train your whole body. It is equipped with various handles that allow you to hold the product in different ways, both horizontally and vertically. This allows you to effectively train the upper body, but it can also be used to train the lower body. AquaRaft also enables you to work in pairs.



### EAA INSTRUCTOR TRAININGS:

Master ACQUAFly - ON DEMAND



Materiale Material	PE foam
Dimensioni Dimensions	37,3 x 60,4 x 17 cm
Profondità d'impiego Depth of use	tutte le prof. d'impiego any depths

### EAA INSTRUCTOR TRAININGS:

Course AQUA FITNESS - First  
Course AQUA FITNESS - Advanced  
Master AQUA CIRCUIT  
Master AQUAxFIT  
Course AQUA PERSONAL PROGRAM



Materiale Material	PVC
Dimensioni Dimensions	99 x 18 x 2,5 cm
Profondità d'impiego Depth of use	tutte le prof. d'impiego any depths



**EAA INSTRUCTOR TRAININGS:**

- Course **AQUA FITNESS - First**
- Course **AQUA FITNESS - Advanced**
- Master **AQUA CIRCUIT**
- Master **AQUAxFIT**
- Course **AQUA PERSONAL PROGRAM**

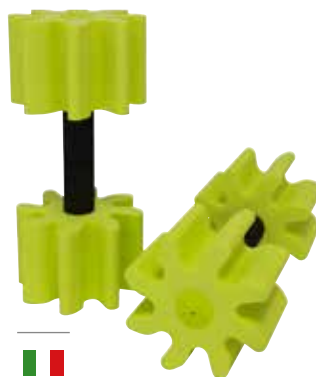

**WAVE BELLS**  
cod. AFT 0030

Coppia di manubri in espanso a forma di onda con impugnatura morbida.

Pair of wave-shaped dumb-bells PE foam made; soft hand grip.

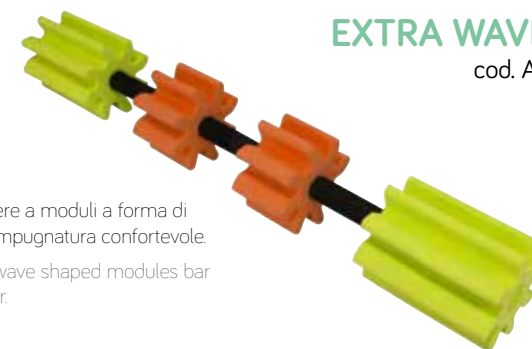

**EXTRA WAVE BAR**  
cod. AFT 0031

Bilanciere a moduli a forma di onda. Impugnatura confortevole.

Foam wave shaped modules bar bicolour.



**AFT 0030**

Materiale  
Material

espanso  
PE foam

Dimensioni  
Dimensions

ø 14 x 30 cm

**AFT 0031**

espanso  
PE foam

ø 14 x 89 cm

**AFT 0032**

espanso  
PE foam

ø 17 x 16,5 cm

**AFT 0004**

espanso  
PE foam

ø 41,5 x 16 cm

Colori  
Colours

secondo disponibilità  
on availability

**BIG WAVE BELLS**  
cod. AFT 0032



Coppia di manubri per un lavoro più intenso, rispetto al manubrio classico.

Strong pair of dumb-bells PE foam made. Soft hand grip. Allows harder work than the standard dumb-bells.



**HANDFINS 300**  
cod. AFT 0004



Coppia di pagaiette indicate per gli arti superiori. Valide per recupero funzionale, intra ed extra rotazioni, adduzioni e abduzioni delle braccia.

Pair of paddles recommended for training upper limbs; ideal for functional rehabilitation, intra and extra rotations and arm adductions and abductions.



## EASY ANKLE CUFFS

cod. AFT 0002

Coppia di cavigliere in morbido foam. Lo spessore rende versatile l'attrezzo anche come polsiera per attività di fitness acquatico o supporto per il galleggiamento dei bambini (arrotoato al braccio).

Pair of soft foam ankle cuffs, the slimmer thickness makes it also suitable as wrist support for aquafitness or children floating support.

sezione  
section



Optional

cod. ARH 0001.3

Elemento in lexan per aumentare la resistenza  
(vedi l'articolo completo pag. 23)

Lexan element to increase the resistance  
(see the complete article page 23)

### EAA INSTRUCTOR TRAININGS:

Course AQUA FITNESS - First

Course AQUA FITNESS - Advanced

Master AQUA CIRCUIT

Master AQUAxFIT

Course AQUA PERSONAL PROGRAM



Materiale  
Material

AFT 0002 Eva Foam injected Eva

AFT 0012 Eva Foam injected Eva

AFT 0033 espanso PE foam

Dimensioni  
Dimensions

AFT 0002 spessore thickness 0,75 - 2,5 cm

AFT 0012 spessore thickness 1 - 5 cm

AFT 0033 15 x 10 cm

## BIG ANKLE CUFFS

cod. AFT 0012

Coppia di cavigliere in morbido foam.  
Pair of soft foam ankle cuffs.

sezione  
section



## WAVE ANKLE CUFFS

cod. AFT 0033

Coppia di cavigliere in espanso a forma di onda.  
Regolazione della chiusura in velcro.

Pair of wave shaped ankle cuffs PE foam made.  
Velcro straps adjustable.



### Ricambi Spare Parts

AFT 0002

AFT 0012

AFT 0033

#### AFT 0212

Fettuccia ricambio velcro  
Binding velcro loop



#### AFT 0209

Velcro piccolo - 2 pz (paio)  
Small velcro strap - 2 pcs (pair)



#### AFT 0210

Velcro grande - 1 pz  
Big velcro strap - 1 pc





**EAA INSTRUCTOR TRAININGS:**

Course **AQUA FITNESS - First**  
 Course **AQUA FITNESS - Advanced**  
 Master **AQUA CIRCUIT**  
 Master **AQUAxFIT**  
 Course **AQUA PERSONAL PROGRAM**



Materiale Material	PVC + poliuretano PVC + polyurethane
Dimensioni Dimensions	ø 30 cm
Profondità d'impiego Depth of use	tutte le prof. d'impiego any depths

Un concentrato di divertimento e versatilità: palla ed elastico per un allenamento completo. La palla sfruttando la resistenza dell'acqua, porta a sviluppare una vasta gamma di esercizi che vanno dalla propriocettività al potenziamento e, associata agli elastici, si trasforma nell'attrezzo più innovativo del momento, anche grazie alla presenza di confortevoli maniglie.

An ideal source of fun and versatility: ball and elastic for a complete workout. Using water as resistance, the ball lets you develop a wide range of exercises, from balance to strength training. Combined with elastics it transforms into the most innovative equipment of the moment, along with comfortable handles.

**MAGIC AQUABALL**

cod. AFT 0013



Accessori Accessory  
 cod. AEB 0062 **OVER BALL**

**EAA INSTRUCTOR TRAININGS:**

Course **AQUA FITNESS - First**  
 Course **AQUA FITNESS - Advanced**  
 Master **AQUA CIRCUIT**  
 Master **AQUAxFIT**  
 Course **AQUA PERSONAL PROGRAM**



Materiale Material	Eva Foam injected Eva
Profondità d'impiego Depth of use	tutte le prof. d'impiego any depths
Dimensioni Dimensions	35 x 18 x 15 cm

Guanti palmati per il nuoto e l'allenamento. Realizzati in elasticissimo neoprene Ultraspan, hanno un rivestimento esterno in colore blu sul dorso, mentre il palmo è realizzato in neoprene monofoderato (fodera sul lato interno) per aumentare il coefficiente d'attrito con l'acqua, ottimizzando la resa propulsiva.

Webbed gloves for swimming and training. Made from ultra-stretch Ultraspan neoprene, the outer coating on the back is dark blue, while the palm is made from single-lined neoprene (lined on the inner) to increase the coefficient of the water drag, optimising thrust.

**EXTRA GLOVES**

cod. AFT 0025 mod. **S SIZE**  
 cod. AFT 0026 mod. **M SIZE**  
 cod. AFT 0027 mod. **L SIZE**  
 cod. AFT 0028 mod. **XL SIZE**



**AQUABELT**cod. AFB 0001 mod. **MEDIUM**cod. AFB 0002 mod. **LARGE**

Cintura galleggiante in foam adatta a tutte le attività di fitness acquatico, riabilitazione e training in acqua fonda.

Floating belt suitable for aquafitness, rehabilitation and training in deep water.

**Ricambi | Spare parts****AFB 0100**

chiusura completa per AQUABELT  
AQUABELT complete closing set

**AQUABELT BASIC**cod. AFB 0012 mod. **MEDIUM**

Cintura galleggiante in foam adatta a tutte le attività di fitness acquatico, riabilitazione e training in acqua fonda.

Floating belt suitable for aquafitness, rehabilitation and training in deep water.

**RESISTANCE BAND**cod. AFB 0512 mod. **MEDIUM** - ■ redcod. AFB 0513 mod. **STRONG** - ■ greencod. AFB 0514 mod. **EXTRA STRONG** - ■ blue**ACTIVE TUBE**cod. AFB 0503 mod. **SOFT** - ■ yellowcod. AFB 0504 mod. **MEDIUM** - ■ bluecod. AFB 0505 mod. **STRONG** - ■ silver**Su richiesta | On request****AFB 0507**

coppia di maniglie  
pair of basic handles

**AFB 0506**

moschettone  
karabiner

**EAA INSTRUCTOR TRAININGS:**Course **AQUA FITNESS** - FirstCourse **AQUA FITNESS** - AdvancedMaster **AQUA CIRCUIT**Master **AQUAxFIT**Course **AQUA PERSONAL PROGRAM**

	Misura Size	Materiale Material	Dimensioni Dimensions
<b>AFB 0001</b>	MEDIUM	espanso	77 x 19,5 x 4 cm
<b>AFB 0002</b>	LARGE	PE foam	87 x 19,5 x 4 cm
<b>AFB 0012</b>	MEDIUM	espanso PE foam	76 x 19 x 4 cm
<b>AFB 0512</b>	MEDIUM	latex, pvc free	23 m x 15 cm
<b>AFB 0513</b>	STRONG		
<b>AFB 0514</b>	EXTRA STR.		
<b>AFB 0503</b>	SOFT		5 mm x 10 mm
<b>AFB 0504</b>	MEDIUM		7 mm x 10 mm
<b>AFB 0505</b>	STRONG		8 mm x 10 mm

**EAA INSTRUCTOR TRAININGS:**

Course **AQUA FITNESS - First**  
 Course **AQUA FITNESS - Advanced**  
 Master **AQUA CIRCUIT**  
 Master **AQUAxFIT**  
 Course **AQUA PERSONAL PROGRAM**



	Materiale Material	Dimensioni Dimensions
<b>AFB 0011</b>	espanso PE foam	
<b>AFB 0005</b>		SMALL ■ blue royal
<b>AFB 0006</b>		MEDIUM ■ blue royal
<b>AFB 0007</b>		LARGE ■ blue royal
<b>AFT 0004.2</b>	espanso PE foam	ø 12,5 x 30 cm
<b>AFT 0003.2</b>	espanso PE foam	62 x 12 x 2 cm

**EASY COMBAT GLOVES**

cod. AFB 0011



Coppia di comodi aqua combat gloves in morbido espanso.  
 Pair of aquacombat gloves. Comfortable PE foam.

**AQUAGLOVES**

cod. AFB 0005 mod. **SMALL**  
 cod. AFB 0006 mod. **MEDIUM**  
 cod. AFB 0007 mod. **LARGE**



Coppia di guantini in neoprene con chiusura in velcro.  
 Pair of neoprene aquagloves with velcro.

**AQUABELLS**

cod. AFB 0004.2



Colori  
 Colours | secondo disponibilità  
 on availability

Coppia manubri in espanso per attività di fitness in acqua.  
 Maniglia con morbido grip.

Pair of PE foam dumb-bells, for aquafitness activities.  
 Soft hand grip.

**AQUAWRISTES**

cod. AFB 0003.2



Coppia di polsiere galleggianti in espanso con chiusura regolabile in velcro.  
 Pair of PE foam wrist with adjustable velcro strap.

## AQQUNIVERSAL RINGS

cod. AQU 0003



Coppia di anelli ideali per qualsiasi attività in piscina, realizzati per completare il sistema Aqqatube destinato ad attività di relax e aquatic wellness. **Rieducazione funzionale:** con fettuccia di regolazione diventano un eccellente collarino. **Didattica:** ottimi per l'insegnamento del nuoto e attività ludica. **Nuoto:** incrociando l'anello è possibile applicarlo alle caviglie per limitare l'uso della gambata. **Aquafitness:** impugnato in diversi modi esercita un'apprezzabile resistenza. **Sicurezza:** sotto sorveglianza di un adulto è una valida ciambella galleggiante.

Pair of multipurpose swimming pool rings, they complete the Aqqatube system and are designed for relax and aquatic wellness. **Rehabilitation:** with the adjustable connector strap it can be shaped as an excellent collar. **Swimming teaching and Fun.** **Swimming:** limitation of the kick by crossing the ring and applying it around the ankles. **Aquafitness:** it can be grasped in different ways and applies a considerable resistance. **Safe:** under an adult watch it could be used as a life belt.



### EAA INSTRUCTOR TRAININGS:

Course **AQUA FITNESS - First**  
 Course **AQUA FITNESS - Advanced**  
 Course **AQUA PERSONAL PROGRAM**  
 Course **ATTIVITÀ IN ACQUA PER GESTANTI**  
 Course **ACQUA E DISABILITÀ**



<b>Materiale</b> Material	Eva Foam injected Eva
<b>Dimensioni</b> Dimension	ø 34 cm
<b>Profondità d'impiego</b> Depth of use	tutte le prof. d'impiego any depths
<b>Colori</b> Colours	■ lilla ■ green secondo disponibilità based on availability

## NEKDOODLE®

cod. AQU 0006



Nekdoodle® è un ausilio per le attività acquatiche. Si tratta di un cuscino galleggiante da indossare al collo. Utile durante il nuoto, le attività di relax o riabilitazione, oppure per il semplice galleggiamento. Adatto a tutte le fasce di età, Nekdoodle® è un prodotto brevettato a Stockton, in California (USA).

Nekdoodle® is a fantastic and new water fitness aid. Cushion your neck while swimming, rehabbing, and working out in water with a patented floatation device from our company in Stockton, California. Perfect for swimmers worldwide, the Nekdoodle® water cushion supports the head and neck for use in water fitness, recreation, relaxation, and aquatic therapy. Its multifunctional appeal as an aerobic kickboard, a floatation device, and a seat cushion makes it popular with all ages.



### EAA INSTRUCTOR TRAININGS:

Course **AQUA FITNESS - First**  
 Course **AQUA FITNESS - Advanced**  
 Course **AQUA PERSONAL PROGRAM**  
 Course **ATTIVITÀ IN ACQUA PER GESTANTI**  
 Course **ACQUA E DISABILITÀ**





### EAA INSTRUCTOR TRAININGS:

Course **AQUA FITNESS - First**  
 Course **AQUA FITNESS - Advanced**  
 Course **AQUA PERSONAL PROGRAM**  
 Course **ATTIVITÀ IN ACQUA PER GESTANTI**  
 Course **ACQUA E DISABILITÀ**



Materiale Material	Eva Foam injected Eva
Profondità d'impiego Depth of use	> 180 cm
AQU 0001 AQU 0002	50 - 70 Kg > 70 Kg
Colori (secondo disponibilità) Colours (based on availability)	



### CONSUMO CALORICO

30' di lavoro  
Intensità

200-400 calorie  
medio-alta

### BURNED CALORIES

30' workout  
Intensity

200-400 calories  
medium-high

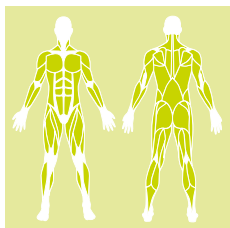

Indicato per il neofita, è ideale per chiunque intenda vivere l'acquaticità in pieno comfort e per qualsiasi impiego. Disegnato per ottimizzare la sua capacità galleggiante: all'altezza dell'addome la sezione dell'ausilio risulta doppia rispetto a quella che avvolge il collo; questa distribuzione del materiale galleggiante rende più confortevole, efficace e sicuro il sistema Aquatube. Indicato anche per rehab e attività con diversamente abili.

Innovative equipment which allows safety and freedom of movement in the water. Suitable for beginners, it is the ideal device to enjoy water in every activity. It is designed to optimize its floating capacity. The diameter of the equipment around the belly is double than its section around the neck. This rational distribution of the floating material makes the Aquatube even more comfortable and safe.

**AQUATUBE**  
 cod. AQU 0001 mod. **MEDIUM**  
 cod. AQU 0002 mod. **LARGE**



Su richiesta | On request

**AQU 0201**  
 chiusura a clip  
 closing clip



**AQU 0200**  
 2 fettucce e chiusura a clip completa  
 complete closing set



## AQUA PANTS

cod. AFT0024



Pantalone per attività in acqua, misto cotone, con fascia addominale in cotone elasticizzato, ideale per rendere l'attività in acqua più dispendiosa e contemporaneamente procurare una sorta di massaggio alla parete addominale.

Presenta cinturina elasticizzata con fermi sulla parte terminale per stringere il pantalone alla vita durante l'esercizio.

Colori di serie: Bianco/Blu e Nero/Blu. Taglia S, M, L, XL.

Trousers for activities in water, cotton blend, with abdominal stretch cotton band, ideal to make the activity in water more expensive and at the same time provide a sort of massage to the abdominal wall.

It has an elastic strap with closing on the terminal part to tighten the trousers to the waist during exercise.

Standard colors: White/Blue and Black/Blue. Size S, M, L, XL.



**Materiale**  
Material

pantaloni in microfibra e nastri in poliestere  
microfiber trousers and polyester cords

**Prof. d'impiego**  
Depth of use

tutte le prof. d'impiego  
all depths

**Taglie**  
Sizes

S - M - L - XL

**Colori**  
Colours

bianco, nero  
white, black

laccio di regolazione caviglia  
ankle cord



## AQUA PANTS

fascia addominale in cotone elasticizzato  
abdominal stretch cotton band



laccio di regolazione vita  
waist cord



# CRESSI

## RASH GUARD T-SHIRT

**AUMENTA DI 2°C LA TEMPERATURA CORPOREA IN ACQUA**  
**INCREASES THE BODY TEMPERATURE OF 2°C IN WATER**

T-shirt studiate per prevenire danni cutanei dovuti a raggi UV. Facilita la termoregolazione corporea di grandi e piccoli, evitando che abbiano freddo, soprattutto nelle fasi di uscita dalla vasca o nel caso la temperatura sia inferiore ai 32°C.

T-shirts designed to prevent skin damage from UV rays. Facilitates body thermoregulation in children and adults, preventing them from feeling cold, especially when getting out of the pool and in temperatures below 32°C.

<b>MAN</b>	<b>cod. CRS 0011</b>	S/2 - M/3 - L/4 - XL/5 - XXL/6 - XXXL/7
<b>LADY</b>	<b>cod. CRS 0021</b>	XS/1 - S/2 - M/3 - L/4 - XL/5
<b>BOY</b>	<b>cod. CRS 0031</b>	XS/1 - S/2 - M/3 - L/4 - XL/5
<b>GIRL</b>	<b>cod. CRS 0032</b>	XS/1 - S/2 - M/3 - L/4 - XL/5



MAN

LADY

BOY

GIRL

## RASH GUARD LONG

**AUMENTA DI 2°C LA TEMPERATURA CORPOREA IN ACQUA**  
**INCREASES THE BODY TEMPERATURE OF 2°C IN WATER**

Maglietta protettiva a maniche lunghe, in speciale tessuto altamente elastico. Buona protezione sia in acqua, sia all'asciutto da sole, vento e basse temperature.

This long-sleeved protective t-shirt is made from special, stretchy material. It offers excellent protection from the sun, wind and low temperatures either in the water or when dry.

<b>MAN</b>	<b>cod. CRS 0033</b>	S/2 - M/3 - L/4 - XL/5 - XXL/6 - XXXL/7
<b>LADY</b>	<b>cod. CRS 0034</b>	XS/1 - S/2 - M/3 - L/4

 MAN  
LADY

 KIDS SHORTY  
BOY/GIRL

**AUMENTA DI 2°C LA TEMPERATURA CORPOREA IN ACQUA**  
**INCREASES THE BODY TEMPERATURE OF 2°C IN WATER**

Monopezzo senza cappuccio a maniche corte e pantaloncini, realizzato in neoprene bifoderato. Cerniera frontale con sottocerniera, chiusura regolabile al collo.

Hoodless short sleeve and short leg one-piece suit, made in double lined neoprene. Back zipper with inner flap, adjustable collar.

neoprene 2 mm	XS/1 S/2 - M/3 - L/4 - XL/5 - XXL/6 - XXXL/7 XS/1 - S/2 - M/3 - L/4 - XL/5
neoprene + lycra 1,5 mm	S/1 (1/2 anni years) - M/2 (2/4 anni years) L/3 (4/6 anni years) - XL/4 (6/8 anni years) XXL/5 (8/10 anni years)

## LITTLE SHARK

cod. CRS 0041 - BOY  
 cod. CRS 0041.1 - GIRL



Taglie Sizes	8/10/12 anni years
Materiale Material	85% neoprene + 15% elastane
Spessore Thickness	2 mm

Mutino corto in tessuto altamente elastico e neoprene. Offre una buona protezione sia in acqua sia all'asciutto da sole, vento e basse temperature. Efficace al mare anche come protezione contro le meduse.

Swimwear and UV protection in one and can be combined with UV protection to wear. Anti-Jellyfish.

## INFANT BABY WARMER

cod. CRS 0042 - BOY  
 cod. CRS 0042.1 - GIRL



<b>S</b>	6 - 12 mesi months
<b>M</b>	12 - 18 mesi months
<b>L</b>	18 - 24 mesi months

Protezione termica per neonati/bambini, realizzata in neoprene che riscalda e protegge dal sole (nelle zone coperte) chi la indossa.

- Mantiene al caldo i bambini esposti all'ambiente acquatico.
- Apertura con velcro per l'accesso ai pannolini da nuoto Cressi.
- Agevola il galleggiamento, ma non è un dispositivo salvavita.
- Deve sempre essere usata sotto la supervisione degli adulti.

This infant/baby warmer has been constructed with neoprene which warmth and sun protection to the wearer on covered parts.

- Keeps children warm when exposed to aquatic environment
- Positively buoyant which assists with back flotation for survival breathing training
- Easy access for use with cressi swim diapers
- Kid safe but is not a life saving device.

Should always be used under adult supervision.

**ACQUAMI®**

ACQUAMI® è un nuovo modo di "vivere l'acqua" e di allenarsi per trovare benessere psicofisico, basato sul controllo posturale in acqua. L'originalità di questa nuova attività consiste nelle 24 Andature Acquami o "posture di avanzamento", cioè nuove modalità per percorrere le vasche. Per eseguirle correttamente è prevista una vasta serie di esercizi preparatori, nonché precise progressioni didattiche da eseguire in diverse altezze dell'acqua. Le andature vengono eseguite con l'utilizzo di due attrezzi ideati e brevettati appositamente per questa attività: Onda e Sella sono attrezzi da applicare all'andatura o all'esercizio proposto a seconda dell'obiettivo da raggiungere.

ACQUAMI® is a new way of "experiencing water" and training for physical and mental wellbeing, based on posture control in the water. The originality of this new activity consists in 24 Acquami Strokes or "advancing postures", new ways of covering a length. Preparation to achieve the correct posture consists in a wide range of progressive exercises to be performed in different water depths. Acquami strokes are performed with the help of two specifically patented devices: Onda and Sella are two different accessories used during Acquami exercises depending on the objective of the activity.

**ONDA**

cod. AQM 0002 - TAVOLA  
cod. AQM 0003 - INSERTO CILINDRO



Onda è un attrezzo composto da un supporto galleggiante appiattito e un cilindro. Può essere utilizzato in modalità "Base" (cilindro nel suo apposito alloggiamento), oppure in modalità "Composta" (quando il cilindro è montato nei fori centrali). Le due modalità di utilizzo dell'Onda (Base o Composta) influiscono sulla capacità di galleggiamento dell'attrezzo e lo rendono più o meno maneggevole.

Onda is a device comprising a flat, floating support and a cylinder. It can be used in "Basic" mode (with the cylinder in its holder) or in "Composite" mode (with the cylinder inserted in the central hole). Onda's two modes (Basic and Composite) affect the device's capacity to float and make it more or less easy to handle.

**KIT ACQUAMI COMPLETO**

cod. AQM 0004



CE

**SELLA**

cod. AQM 0001



La Sella ha una forma anatomica e si adatta perfettamente agli esercizi che mirano al controllo posturale fornendo un minimo appoggio galleggiante instabile.

Sella has an anatomic shape and is ideal for exercises that aim to improve posture control, providing minimum and unstable floating support.

**EAA INSTRUCTOR TRAININGS:**

Course **AQUA POSTURAL TRAINING**  
by AcquaMi®



<b>Materiale</b> Material	Eva Foam injected Eva
<b>Dimensioni ONDA</b> ONDA dimensions	23,5 x 40 x 8 cm
<b>Dimensioni SELLA</b> SELLA dimensions	24 x 17 x 8 cm
<b>Dimensioni CILINDRO</b> CILINDRO dimensions	24 x 9 x 6 cm
<b>Profondità d'impiego</b> Depth of use	> 120 cm





AQUAREHAB



**SINGLE REHAB PADDLE**

cod. ARH 0002



Ideale per il recupero funzionale degli arti superiori. È possibile regolare l'ampiezza fori delle pale per modulare intensità dello sforzo, in particolare per intra ed extra rotazione dell'arto superiore, abduzione e adduzione, flessione-estensione. Realizzato in policarbonato è suggerito anche per training e preparazione atletica in acqua.

Ideal for the functional recovery of arms and related joints, muscle and tendons, in particular for internal and external rotation of the upper limb, abduction and adduction, flexion and extension. Provided with an adjustment system of wideness paddles holes for modulating intensity of the exercise effort. Made of polycarbonate, recommended for training and athletic training in water thanks to its features.

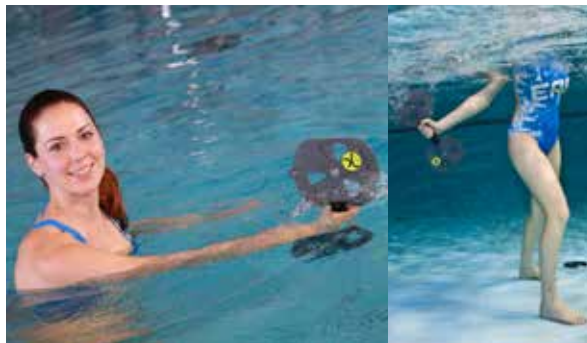

**EAA INSTRUCTOR TRAININGS:**  
Course **AQUA PERSONAL PROGRAM**

**AQUA BALANCE BOARD**cod. ARH 0003 mod. **MEDIUM**cod. ARH 0003.1 mod. **LARGE**

Dimensioni	<b>MEDIUM</b>	ø 38 cm
Dimensions	<b>LARGE</b>	ø 50 cm

Attrezzo per la rieducazione articolare della caviglia e dell'allenamento propriocettivo, preventivo e rieducativo, delle articolazioni degli arti inferiori e della spalla. La versione con diametro più largo è adatta per eseguire balzi in acqua con atterraggio sulla pedana per le esercitazioni di propriocettività dinamica (balzi, percorsi etc.) e, quindi, per attività più impegnative e di livello superiore.

Tool for rehabilitation of the ankle joint and proprioceptive training, preventive and rehabilitation, the joints of the legs and shoulder. The version with a larger diameter is suitable for performing jumps in the water with landing on the platform for dynamic proprioception exercises (jumps, trails, etc.) and, therefore, for the most demanding tasks and higher level.



**EAA INSTRUCTOR TRAININGS:**  
Course **AQUA PERSONAL PROGRAM**

**LEG & ARM PADDLE**cod. ARH 0001.1 mod. **SIMPLE**cod. ARH 0001 mod. **DOUBLE**

Materiale	Eva Foam + policarbonato	<b>vendita singolo pezzo</b> <b>sold by piece</b>
Material	injected Eva + polycarbonate	

Studiato e progettato per il recupero funzionale e la riabilitazione di arti inferiori e superiori. La paletta, in policarbonato ha una forma ondulata per ridurre resistenze disomogenee in acqua. L'alloggio dell'arto è reso confortevole dalla cavigliera/polsiera **cod. AFT 0002** in Eva iniettata (vedi pag. 6); le fettucce regolabili, conferiscono stabilità alla paletta e sono dotate di anelli autobloccanti.

Designed and developed for functional recovery and rehabilitation of upper and lower limbs in water. The paddle in polycarbonate, has a wavy shape to reduce uneven resistance during movement. The location of the art is made comfortable by the ankle injected EVA **cod. AFT 0002** the adjustable straps (see page 6), give stability to the paddle and are equipped with locking rings.



**EAA INSTRUCTOR TRAININGS:**  
Course **AQUA PERSONAL PROGRAM**





AQUATIX NASCE NEL 2006, GRAZIE AD IDEE E COMPETENZE DI PERSONE  
CON OLTRE 30 ANNI DI ESPERIENZA TECNICA, SPORTIVA, CULTURALE  
ED IMPRENDITORIALE NEL SETTORE PISCINA.

AQUATIX WAS CREATED IN 2006 BY THE WILL OF YOUNG ENTREPRENEURS,  
WILLING AND ABLE TO ENTER INTO THE WATERWORLD WITH NEWS  
AND DETERMINATION.

## Vision

Acqua come stile di vita e contesto imprescindibile per ogni individuo (motoriamente attivo o inattivo): benessere, salute, prevenzione e divertimento possono essere veicolati dall'acqua, attraverso la realizzazione e l'utilizzo di attrezzi, ausili, giochi che facilitino le percezioni e le sensazioni che l'acquaticità può regalare, percorrendo i tempi, innovando e promuovendo una ricerca costante, senza trascurare l'oggi, fatto di tradizione e certezze.

To be the best interpreters of Wellness conveyed to water through the creation of tools and aids that facilitate the perceptions and feelings that can give aquatic world, going through the time with innovation and being at the forefront, without leaving aside the today tradition and certainty.

Interpretare l'Acqua come fonte di salute e benessere autentici, perseguibili grazie ad attrezzature o soluzioni studiate e realizzate con rigore etico, scientifico, professionale e massima sensibilità per design, sicurezza e qualità (EAA e il centro R&D di Aquatix), partendo dall'analisi dei bisogni di ogni persona e armonizzando ogni scelta con le esigenze pratico-strategico-imprenditoriali di chi crede nell'acqua come ambiente ideale. Acqua come elemento declinabile in tutte le sue interpretazioni volte a garantire emozioni ed esperienze positive per l'individuo, facilitate da attrezzature uniche al mondo. Acqua come idea universale di benessere, salute, prevenzione, movimento, divertimento e relax, proiettata su scala mondiale.

## Mission

To interpret water as a source of true wellness, enhancing the benefits through equipment designed and built according to this priority, whereas conscious and unconscious needs of consumer and reconciling the needs of practical and strategic-business trade, the latter not only understood as pool, but also as a spa, entertainment and recreation center, no longer limited to the national context, but above all outside our borders, projecting also to medium-high pool of housing. The same time be aware of the role of a guide that enhances the equipment to enhance the properties of water by the appropriated and correct use of it.

Le immagini e i testi di questo catalogo si intendono a titolo indicativo.  
Aquatix si riserva di apportare modifiche ai prodotti in qualsiasi momento e senza preavviso.  
The pictures and descriptions in this catalogue are provided solely as a guide.  
Aquatix reserves the right to make any change to the products at any time and without notice.

**aqquatix**<sup>®</sup>  
equipment for very aqquatix people

**AQQUATIX SRL**  
Limena (Padova)  
ITALY  
T. +39 049 738 11 50

[www.aqquatix.com](http://www.aqquatix.com)  
Italy: [info@aqquatix.com](mailto:info@aqquatix.com)  
Export: [export@aqquatix.com](mailto:export@aqquatix.com)

Training by EAA  
[www.euroaquatic.it](http://www.euroaquatic.it)



equipment for very aqquatix people

AQUAKID FUN&ENJOY AQUATIC&SWIM AQUAPOOL



EUROPEAN AQUATIC ASSOCIATION

# Index

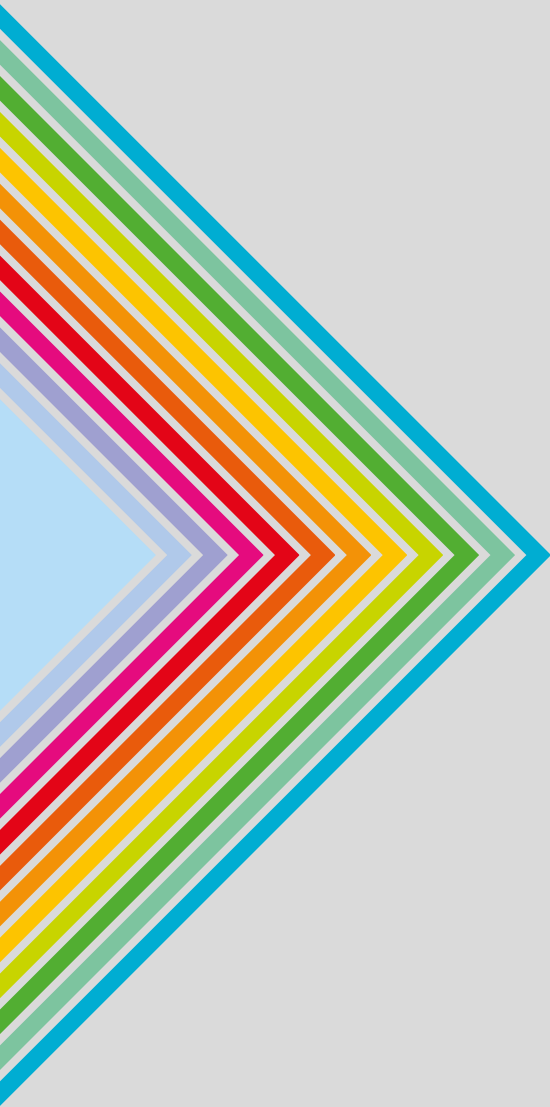

	<b>Aquakid</b>
4	<b>AQUAKID CONNECTION</b>
6	<b>AQUAKID TOP</b>
10	<b>AQUAKID BASIC</b>
	<b>Fun &amp; Enjoy</b>
16	<b>NOODLES</b>
17	<b>ATTREZZATURA FUN</b>
18	<b>WIBIT</b>
	<b>Aquatic &amp; Swim</b>
22	<b>BOARDS</b>
23	<b>SWIM INSTRUMENTS</b>
25	<b>PADDLES</b>
26	<b>FINS</b>
27	<b>ELECTRONICS</b>
	<b>Aquapool Line</b>
30	<b>BOXES and SHELVES</b>
31	<b>CLOCK + BOXES</b>
32	<b>PEDANE</b>
33	<b>BLOCCHI PARTENZA + BOARD GUARD+ BANDIERINE</b>
34	<b>CORSIE + MOLLE + TENDITORE</b>

## Icons



**CORSI DI FORMAZIONE**  
TRAINING COURSES

**CARATTERISTICHE TECNICHE**  
TECHNICAL FEATURES

**CONSUMO CALORICO**  
BURNED CALORIES



\* Tutti i prodotti Aqqatix sono raccomandati da EAA

\* All Aqqatix products are recommended by EAA

[www.euroaquatic.it](http://www.euroaquatic.it)

AQUAKID





foto di Tata O Club

## AQUAKID CONNECTION

### FLOWER BUOY

cod. AKC 0030

Boa a fiore con fori per Noodle e Pvc Sticks.  
Flower buoy with holes for Noodles and PVC Sticks.

**Dimensioni** Dimensions: 26 x 26 x 9 cm



### PVC STICK

cod. AKC 0051

Bastoni in pvc per gli assemblaggi.  
Sticks in PVC necessary for assembly.

**Dimensioni** Dimensions: 100 x Ø 2,5 cm





### CAR

cod. AKC 0044



Dimensioni  
Dimensions | 100 x 65 x 9 cm

### LOCOMOTIVE

cod. AKC 0045



Dimensioni  
Dimensions | 100 x 63 x 9 cm

### COACH

cod. AKC 0046



Dimensioni  
Dimensions | 75 x 28 x 9 cm

### SHIP

cod. AKC 0047



Dimensioni  
Dimensions | 100 x 54 x 9 cm

## AQUAKID CONNECTIONS



Con la linea AquaKid Connection è possibile realizzare scivoli, zattere, giochi cavalcabili, percorsi in superficie e/o subacquei. Espanso con trattamento antibatterico.

With the AquaKid Connection line it is possible to create slides, rafts, rides, and floating/underwater paths. Antibacterial treatment foam.



### CLOUD WAVE CARPETS



cod. AKC 0001 | 100 x 50 x 4,5 cm  
cod. AKC 0002 | 100 x 100 x 4,5 cm  
cod. AKC 0004 | 200 x 100 x 4,5 cm  
cod. AKC 0008 | 200 x 100 x 9 cm

### CLOUD & HOLES CARPETS



cod. AKC 0009 | 100 x 50 x 4,5 cm  
cod. AKC 0012 | 200 x 100 x 4,5 cm  
cod. AKC 0016 | 200 x 100 x 9 cm

### ROUND CLOUD & HOLES CARPETS



cod. AKC 0019 | 100 x 100 x 4,5 cm  
cod. AKC 0020 | 100 x 100 x 9 cm

### CONNECTION ELEMENTS

Elementi di raccordo con fori per Noodles.  
Connection components with holes for Noodles

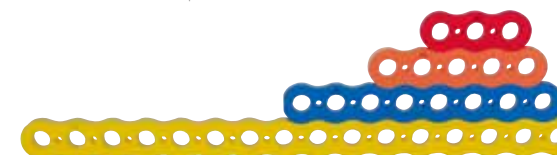

	Dimensioni Dimensions	Fori Holes
cod. AKC 0021	38,5 x 14 x 4,5 cm	3
cod. AKC 0022	62,5 x 14 x 4,5 cm	5
cod. AKC 0023	99 x 14 x 4,5 cm	8
cod. AKC 0024	198 x 14 x 4,5 cm	16

## MODULAR CARPETS

cod. AET 0029 Modular carpet (no fori - no holes)

cod. AET 0030 Holes modular carpet

Tappeto galleggiante in Eva Foam altamente durevole e resistente. Indicato per attività didattiche e ludiche. Si possono costruire infinite combinazioni di percorsi, utilizzando apposite cinghie di collegamento tra un tappeto e l'altro. Il modello AET0030 è dotato anche di fori più grandi, per creare divertenti combinazioni con i Noodles.

This floating, durable and resistant Eva Foam carpet is suitable for educational activities and games. You can construct endless combinations of paths, using belts for connection between carpets. This item is also equipped with big holes AET 0030 to create fun combinations with Noodles.



Dimensioni  
Dimensions

101,5 x 52 x 2 cm

Colori  
(secondo disponibilità)  
Colours  
(based on availability)



### EAA INSTRUCTOR TRAINING

Course **INSTRUCTOR Basic** in ACQUATICITÀ NEONATALE 0-3 anni

Course **INSTRUCTOR Advanced** in ACQUATICITÀ NEONATALE 0-3 anni



Su richiesta | On request

cod. AET 0031

Cinghia di collegamento  
Connecting belt

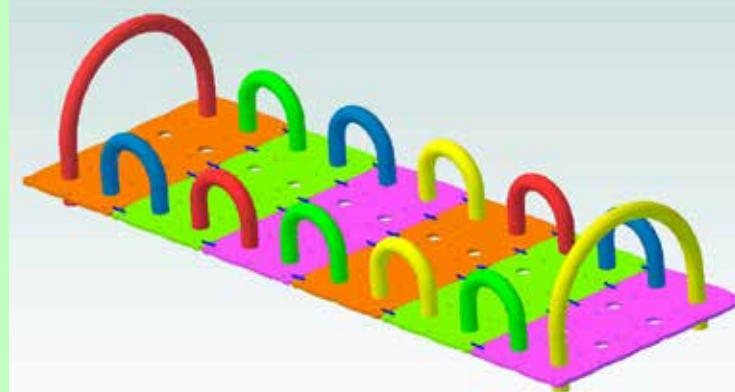
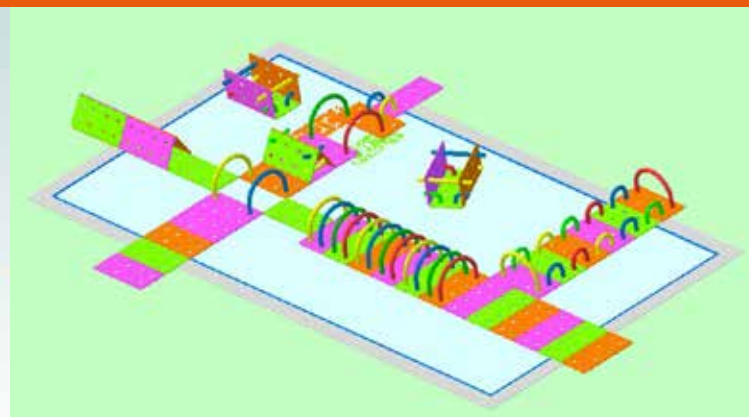
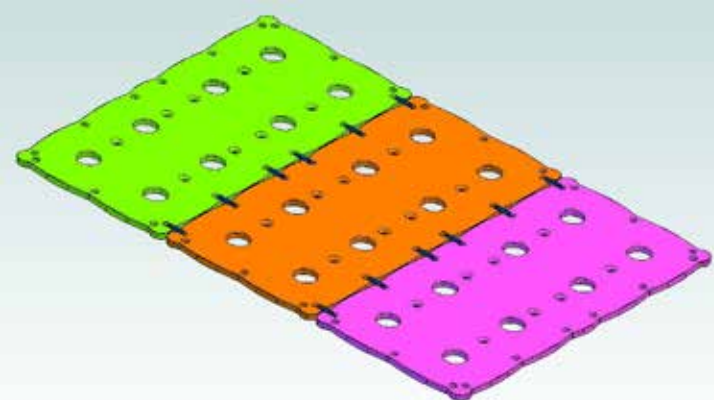



**Dimensioni**  
Dimensions

**Colori**  
(secondo disponibilità)  
Colours  
(based on availability)

**cod. AET 0003** 90 x 200 x 3 cm  
**cod. AET 0001** 65 x 87 x 3 cm



### EAA INSTRUCTOR TRAINING

Course **INSTRUCTOR Basic** in **ACQUATICITÀ NEONATALE 0-3 anni**

Course **INSTRUCTOR Advanced** in **ACQUATICITÀ NEONATALE 0-3 anni**

Tappeto galleggiante in Polymat® altamente durevole e resistente. Indicato per attività didattiche e ludiche.

Wavy floating Polymat® carpet durable and resistant, recommended for educational and learning activities.



## ONDA MAXI - ONDINO

cod. AET 0003 - ONDA MAXI

cod. AET 0001 - ONDINO

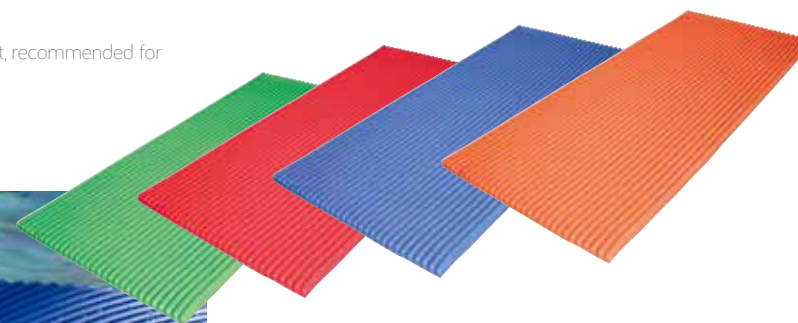

POLYMAT®: MATERIALE A STRUTTURA MICROCELLULARE, CON ELEVATA RESISTENZA, ATOSSICO E GARANTITO SULLA SICUREZZA. IGIENICO E CERTIFICATO CE.

POLYMAT®: MICROCELLULAR MATERIAL, WITH HIGH STRENGTH AND ELASTICITY, NON-TOXIC AND SAFE, VERY HYGIENIC AND CE CERTIFIED.

## TONDOLO + 2 ANELLI



Tubicino galleggiante per didattica e attività ludiche.  
Floating tube and rings for educational and learning activities.

**Materiale** Material  
**cod. AET 0004**  
**cod. AET 0005**  
**cod. AET 0006**  
**cod. AET 0100**

Polymat®  
Tondolo 2 m + 2 anelli rings  
Tondolo 1,5 m + 2 anelli rings  
Tondolo 1 m + 2 anelli rings  
anelli di ricambio  
replacement rings



## BASTONE ZAVORRATO



Bastoncino in pvc zavorrato indicato come gioco didattico: stimola la capacità d'immersione del bambino.

Ballasted stick recommended for educational plays: stimulates the child's diving skills.

**cod. AET 0015**  
**cod. AET 0016**

pvc 50 cm - 320 gr  
pvc 100 cm - 640 gr



## TUNNEL SUB

cod. AET 0019

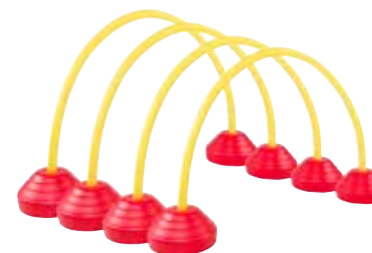

Set di 4 archi (in Polymat®) con basi tonde per creare percorsi subacquei.

Set of 4 arches with bases to create underwater paths.

**Confezione**  
Package

4 Tondolo 1,5 m + 8 basi tonde  
4 Tondolo 1,5 m + 8 round bases



## CIRCO Ø 44 CM



**cod. AET 0022**

**CIRCO 150**  
(Tondolo 1,5 m)

**cod. AET 0023**

**CIRCO 200**  
(Tondolo 2 m)

Combinazione per creare un percorso subacqueo o galleggiante.

Combines to create an underwater path or floating course.

**Confezione**  
Package

1 Polycerchio, 1 Tondolo, 1 anellino, 1 base tonda  
1 Polycerchio, 1 Tondolo, 1 ring, 1 round base



## GYM RINGS

cod. AET 0201

Anelli in Pvc galleggianti ideati per divertire e facilitare l'affinamento di abilità acquatiche del bambino.

Floating PVC rings designed to entertain and improve children's aquatic abilities.



Confezione Package	4 pezzi 4 pieces
Colori Colours	assortiti mixed

## EASY GRIP

cod. AET 0208

Palle in PVC galleggianti con rilievi per facilitare la presa; indicate per divertire il bambino e sviluppare capacità sensoriali dentro e fuori acqua. Valide anche per giochi a terra.

Floating PVC balls with bumps for easy grip. Recommended for entertaining children and developing sensory capabilities in and out of water. Ideal for games out of the water as well.



Diametro Diameter	10 cm
Confezione Package	6 pezzi 6 pieces

## DISC'O' BOCCE

cod. AET 0203

Dischetti in Pvc, galleggianti ideati per divertire simulando il gioco delle bocce in acqua o a terra (kinderheim o palestra).

Floating PVC discs, designed to entertain by simulating the bowls game in or out of water (kindergarten or gym).



Confezione Package	9 pezzi 9 pieces
Colori Colours	assortiti mixed

## FREE BALLS



Palline in Pvc, galleggianti ideate per divertire, richiamare l'attenzione del bambino, grazie alla varietà di colori, e stimolare il recupero attraverso il gioco e il movimento in acqua. Il tutto per agevolare il miglior ambientamento e sviluppare capacità motoria del bambino in acqua.

**Attenzione: AET 0204 e AET 0205 NON sono indicate per bimbi di età inferiore a 4 anni. TUTTE VALIDE ANCHE PER GIOCHI A TERRA: kinderheim e ambienti dedicati a bambini.**

Floating PVC balls, designed to entertain, and attract children's attention thanks to the variety of colours, stimulating retrieval through play and movement in water. Designed to promote familiarization and motor skills in water.

**Caution: AET 0204 and AET 0205 are not suitable for children under 4. IDEAL FOR GAMES OUT OF THE WATER AS WELL: kindergartens and children's areas.**

## DISC'O' JUNIOR

cod. AET 0209

Disco gonfiabile e galleggiante in PVC, resistente e durevole.

Inflatable floating PVC disc-kickboard, resistant and durable.



Diametro Diameter	32 cm
Colore Colour	



cod. AET 0204	MINI	Ø 4 cm	60 pezzi pieces
cod. AET 0205	MAXI	Ø 5.5 cm	24 pezzi pieces
cod. AET 0206	LARGE	Ø 7 cm	4 pezzi pieces
cod. AET 0207	UNIVERSAL	Ø 12.5 cm	1 pezzo piece

## POLYCERCHIO



Set di 4 cerchi galleggianti (in Polymat®) stesso diametro, da usare per attività ludiche e didattiche.

Set of 4 floating rings to be used for learning activities and play.

cod. AET 0010  
cod. AET 0011

Ø 24 - 4 pz pcs  
Ø 34 - 4 pz pcs

### SET POLYCERCHIO ASSORITO

cod. AET 0014

24 - 34 - 44 cm  
3 pz pcs

FLOATING  
↑



## ARTICOLI AQUAKID TOP:

### EAA INSTRUCTOR TRAINING

Course INSTRUCTOR Basic in ACQUATICITÀ NEONATALE 0-3 anni

Course INSTRUCTOR Advanced in ACQUATICITÀ NEONATALE 0-3 anni



## SET 4 BASI TONDE

cod. AET 0008



### 4 Basi tonde da zavorrare con chiusura ermetica.

Per zavorrare le basi si consiglia di riempirle con sassolini e acqua.

Si sconsiglia l'utilizzo della sabbia.

### 4 round bases to load with ballast, hermetic cap.

To ballast the bases it's suggested to fill them with pebbles and water. We do not recommend the use of sand.



## SLOW DIVING DISCS

cod. AET 0026



Set di 4 cerchietti affondanti, realizzati con stampo in Eva iniettata, ideali per stimolare subacqueità e abilità nel recupero del cerchietto mentre affonda.

Set of 4 sinking rings.

Diametro  
Diameter

17,5 cm

Confezione  
Package

9 pezzi  
9 pieces

Colori  
Colours

assortiti  
mixed

DIVING  
↓



## AKU RINGS

cod. AET 0200



Anelli in Pvc affondanti per stimolare esplorazioni e abilità subacquee del bambino.

Sinking PVC rings for the exploration and underwater activities for children.

Confezione  
Package

4 pezzi  
4 pieces

Colori  
Colours

assortiti  
mixed

DIVING  
↓



## FLOATING CARPETS

Tappetoni galleggianti in foam in diverse forme originali e giocose. Tutta la gamma ha dimensioni massime di circa 1 m.

Large floating PE foam carpets in various original designs. The whole range has maximum dimensions of approximately 1 m.



### FLOWER CARPET

cod. AEB 0042



Dimensioni  
Dimensions

95 x 96 x 4,5 cm

### FLYING CARPET

cod. AEB 0041



Dimensioni  
Dimensions

104 x 100 x 4,5 cm

### FISH CARPET

cod. AEB 0034

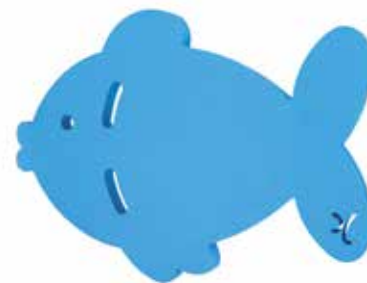

Dimensioni  
Dimensions

68 x 96 x 4,5 cm

### STAR CARPET

cod. AEB 0035



Dimensioni  
Dimensions

104 x 100 x 4,5 cm

## FLOWER HOLES CARPETS

Tappeto galleggiante con fori a forma di fiore.  
Floating carpet with flower-shaped holes.



	Dimensioni Dimensions
cod. AEB 0013	100 x 50 x 1,5 cm
cod. AEB 0014	100 x 100 x 1,5 cm
cod. AEB 0015	150 x 100 x 1,5 cm
cod. AEB 0016	200 x 100 x 1,5 cm
cod. AEB 0017	100 x 100 x 3 cm
cod. AEB 0018	150 x 100 x 3 cm
cod. AEB 0019	100 x 200 x 3 cm



## EAA INSTRUCTOR TRAINING

Course **INSTRUCTOR Basic** in ACQUATICITÀ NEONATALE 0-3 anni  
Course **INSTRUCTOR Advanced** in ACQUATICITÀ NEONATALE 0-3 anni



Tappeto galleggiante con fori grandi.  
Floating carpet with big holes.



<b>Dimensioni</b> Dimensions	100 x 200 x 4,5 cm
<b>Materiale</b> Material	espanso PE foam
<b>Colori</b> Colours	

IN & OUT CARPET  
cod. AEB 0024

## AQUASCOOTER

cod. AEB 0056

Dimensione  
Dimension

60 x 38,5 x 9 cm

Età  
Age

4-6 anni years



Motocicletta in espanso.  
PE foam water scooter.

## ABC FUN

cod. AEB 0057

Dimensione  
Dimension

12 x 10 x 3 cm

Quantità  
Quantity

10 pezzi pieces



Lettere dell'alfabeto galleggianti.  
Floating letters of the alphabet.

## FUNNY NUMBERS

cod. AEB 0058

Dimensione  
Dimension

12 x 10 x 3 cm

Quantità  
Quantity

10 pezzi pieces



Numeri galleggianti.  
Floating numbers.

## AQUASLIDES

cod. AEB 0101 - mod. Regular

cod. AEB 0102 - mod. Maxi

Dimensioni  
Dimensions

cod. AEB 0101  
60x105xh69 cm

cod. AEB 0102

60x160xh98 cm

Età  
Age

3/5 anni years

8/10 anni years

Portata  
Capacity

15/18 kg

22/24 kg

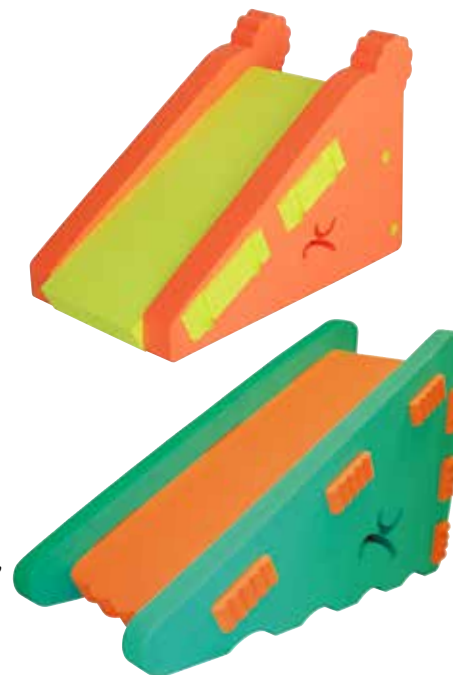

Scivoli in espanso adatti per giochi acquatici e per facilitare l'approccio e l'ambientamento del bambino.

**Attenzione: collocare lo scivolo in acqua lontano dal bordo, per evitare impatti traumatici.**

Slides in expanded foam suitable for water games.

Tutti gli attrezzi per bambini devono tassativamente essere usati con la supervisione di un adulto.

Utilizzo: gli adulti di sorveglianza devono controllare che il bambino salga, si sieda e scivoli in modo corretto.

Scivolare con la testa in avanti è assolutamente **sconsigliato**. lo scivolo va usato solo mettendo il bambino seduto e col busto eretto alla sommità dello scivolo, poi il bambino (con l'aiuto di un adulto) scivolerà verso il basso.



All baby tools must absolutely be used with adult supervision.

Use: the surveillance adults should check that the child goes up, sit down and slides properly. Slide head first is absolutely **not recommended** chute should be used only with child sitting upright and at the top of the chute, then the child (with the help of an adult) will slide down.





**AQUABELT JUNIOR EVOLUTION**

cod. AEB 0030



Cintura galleggiante in espanso a moduli.  
Modular floating belt.

**Dimensione**  
Dimension

57 x 22 cm

**AQUABELT JUNIOR FLOWER**

cod. AEB 0031

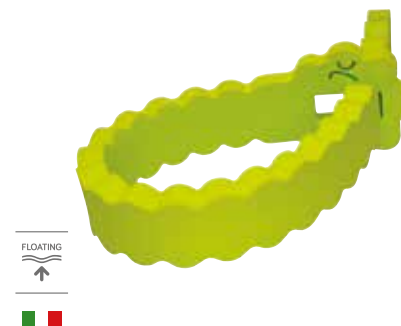

Cintura galleggiante in espanso.  
Floating belt. PE foam.

**Dimensione**  
Dimension

118 x 16 cm

**BABY BASKET**

cod. AEB 0028



Cesta per Baby Carpets.  
Basket for Baby Carpets.

**Dimensione**  
Dimension

70 x 45 x h35 cm

**FLOWER BABY CARPET**

cod. AEB 0039



Zattera porta cesta, in foam, per l'ambientamento facilitato e la sicurezza dei bimbi più piccoli.  
Basket holder raft for the safety of smaller children.

**Dimensione**  
Dimension

98 x 98 x 9 cm



## ARM FLOATZ

cod. AEB 0032

Dimensione Dimension	16 x 14 x 9 cm
Materiale Material	espanso PE foam



Coppia di braccioli in espanso; particolare disegno e il taglio a fisarmonica assicurano il miglior adattamento del bracciolo agli arti superiori di qualsiasi bimbo.

Pair of PE foam arm floats. Special design and accordion-shaped cuts ensure they fit snugly around the upper arms of any child.



## BRACCIOLI

cod. AEB 0505 mod. 0-3 anni years

cod. AEB 0516 mod. > 12 anni years

<b>AEB 0505</b>	0-3 anni years	18,5 x 14 cm
<b>AEB 0516</b>	> 12 anni years	23,5 x 16 cm
Confezione Package	10 paia 10 pairs	



mod. 0-3 anni

mod. > 12 anni

Coppia di braccioli gonfiabili a doppia camera.  
Pair of inflatable double chamber arm floats.  
PVC 0,25 mm

## RINGS

cod. AEB 0519 mod. 0-2 anni years

cod. AEB 0520 mod. 2-3 anni years

cod. AEB 0504 mod. 3-6 anni years

<b>AEB 0519</b>	0-2 anni years	Ø int. 15 cm
<b>AEB 0520</b>	2-3 anni years	Ø int. 16,5 cm
<b>AEB 0504</b>	3-6 anni years	Ø int. 18 cm
Confezione Package	10 pezzi 10 pieces	



Ciambella in PVC gonfiabile.  
PVC inflatable ring.



FUN & ENJOY



## SMILE ANIMALS HEADS

Teste di animaletti in foam, da inserire all'estremità dei noodles per stimolare la fantasia e il divertimento del bambino, spingendolo a cavalcare in acqua il tubo colorato.

PE Foam animal heads to fit at the ends of noodles to stimulate children's imagination and fun, encouraging them to ride the coloured tube in water.children's aquatic abilities.



cod. AFU 0007  
**RABBIT HEAD**

cod. AFU 0009  
**IPPO HEAD**

cod. AFU 0011  
**TIX HEAD**

cod. AFU 0010  
**SHARKY HEAD**

cod. AFU 0008  
**MOBY HEAD**



## CONNECTORS

cod. AFU 0100 - mod. **Multi Holes**

cod. AFU 0101 - mod. **Basic**

Connettori per Noodles con fori laterali per realizzare tunnel e costruzioni galleggianti.

Connectors for Noodles with lateral holes for making tunnels and floating structures.

cod. AFU 0100  
mod. **Multi Holes**

32 x Ø 7 cm 6 fori holes 12 pezzi pieces

cod. AFU 0101  
mod. **Basic**

14 x Ø 7 cm 2 fori holes 24 pezzi pieces



**MULTI HOLES**

**BASIC**

## NOODLES

Tubi galleggianti adatti a qualsiasi attività in acqua. Utili anche per attività ludiche e didattiche.

Floating tubes suitable for any aquatic activity at any depth. Also useful for learning activities and play.



cod. AFU 0006  
cod. AFU 0006.1  
**COLOUR NOODLES**



cod. AFU 0012  
**DYNAMIC NOODLES**



cod. AFU 0006  
cod. AFU 0006.1  
cod. AFU 0012

160 x Ø 7 cm  
24 pezzi pieces  
40 pezzi pieces  
50 pezzi pieces

**THERA BOLLY**

cod. AET 0202



Confezione: 28 palline  
Package: 28 balls

Palline in Pvc con ventosa indicate per kinderheim, ma anche in vasca.  
Vendibile anche nel pro shop interno al centro acquatico/wellness.

PVC balls with suction cups, suitable for playrooms.  
Available for sale at the pro shop inside the aquatic/wellness centre.

**TARTARUGA CAVALCABILE**

cod. AEB 0523

**Dimensioni**  
Dimensions

150 x 60 cm

**Materiale**  
Material

pvc sp. 25/100  
pvc th. 25/100

**MANTA CAVALCABILE**

cod. AEB 0521

**Dimensioni**  
Dimensions

150 x 114 cm

**Materiale**  
Material

pvc sp. 23 mm  
pvc th. 23 mm

**WATER POLO GOAL**

cod. AFU 0502

**Dimensioni**  
Dimensions

213 x 122 x 137 cm

**Materiale**  
Material

PVC

Miniporta pallanuoto, gonfiabile, in pvc.  
Inflatable pvc waterpolo goal.

**AQUA POLO**

cod. AFU 0510

**Dimensioni**  
Dimensions

150 x 80 x 80 cm

**Materiale**  
Material

espanso  
PE foam



Miniporta pallanuoto in pvc.  
Pvc small waterpolo goal.





wibit

wibit

wibit

wibit

wibit

wibit



## COMMERCIAL POOLS e OPEN WATER

**Wibit**, azienda leader nel mercato dei parchi acquatici gonfiabili, con gli spettacolari percorsi modulari offre la possibilità di rendere attrattiva qualsiasi spiaggia o piscina sia indoor che outdoor. Molte sono le proposte per gli Sports Parks standard che possono essere personalizzati in base a specifiche richieste di dimensioni e budget.

L'attenta politica commerciale e marketing, i rigorosi standard di sicurezza e di qualità tedeschi e l'eccellente supporto pre e post vendita garantiscono un elevato livello di servizio agli utenti e un sicuro successo nel business dell'intrattenimento e del fun.

per informazioni  
[www.aqquatix.com](http://www.aqquatix.com)







AQUATIC  
&  
SWIM



## AQUICK BOARDS

mod. PLUS  
cod. SWE 0009



mod. CLASSIC  
cod. SWE 0001



mod. STANDARD  
cod. SWE 0005.1



Eva stiff + grain skin	Eva stiff + grain skin	Soft foam
40 x 30,5 x 3,3 cm	46 x 30,5 x 3,3 cm	46 x 29 x 3 cm
materiale durevole durable foam	materiale durevole durable foam	materiale molto morbido very soft foam
colore <span style="color: red;">■</span> <span style="color: black;">■</span>	colore <span style="color: limegreen;">■</span>	colore <span style="color: limegreen;">■</span>

## AQUICK BOARDS FUN

mod. BUTTERFLY  
cod. SWE 0004.9



Dimensione Dimension	28 x 50 x 3 cm
Materiale Material	Soft foam materiale molto morbido very soft foam

mod. FISH  
cod. SWE 0004.8



Dimensione Dimension	31 x 40 x 3 cm
Materiale Material	Soft foam materiale molto morbido very soft foam

## PULL BUOYS

cod. SWE 0002



cod. SWE 0022



cod. SWE 0010



Eva foam	Eva foam rigido	Eva foam
21 x 12,5 x 8 cm	23 x 12,5 x 8 cm	23 x 10 x 8 cm
materiale durevole durable foam	materiale durevole durable foam	materiale molto morbido very soft foam
blu/bianco blue/white	giallo/nero yellow/black	tinta unita plain colour



**AXIS BUOY**

cod. 1.05.041.05

**FINIS**

Il design dual-function di Axis Buoy migliora la posizione del corpo del nuotatore, mentre lavora la parte superiore del corpo con coinvolgimento dei muscoli del core. Grazie ai due fori ergonomici ed un design sagomato, Axis Buoy può fungere sia come un galleggiante per le caviglie, sia come pull buoy. Il materiale Eva Foam, oltre ad essere leggero, consente una presa sicura alle caviglie, ma permette anche di trasferire facilmente l'attrezzo dalle caviglie alle gambe.

The dual-function design of the Axis Buoy improves body position while building upper body strength and engaging the core muscles. With ergonomic keyholes and a contoured design, the Axis Buoy can function as both an ankle float and a leg buoy. The lightweight EVA foam is lightly textured for a more secure grip and allows swimmers to easily transfer the buoy between ankles and legs.

**ALIGNMENT KICKBOARD YELLOW**

cod. 1.05.042

**FINIS**

Tavoletta in schiuma con elastico per le mani; idrodinamica e ideale per apprendere una corretta posizione corporea.

Designed to maintain optimum body alignment and lengthen body position.

**SWIM PARACHUTE**

cod. 1.05.110.102 - RED 8" (20 cm)

cod. 1.05.110.106 - NAVY 12" (30 cm)

**FINIS**

Swim Parachute viene usato dai migliori allenatori e dagli atleti più veloci del mondo. Permette di nuotare a tutte le velocità e con una vasta gamma di movimenti, pur mantenendo una perfetta stabilità.

Used by the best coaches and the fastest athletes in the world. Swim at normal and much slower speeds with perfect stability and a full range of motion.

**DRYLAND CORDS**

cod. 1.05.113.104 - yellow - LIGHT

cod. 1.05.113.105 - green - MEDIUM

cod. 1.05.113.102 - red - HEAVY

**FINIS**

Elastico con maniglie, adatto alla preparazione atletica a secco dei nuotatori o per il training in generale.

Elastic with handles for resistance swim training.



## KICK PRO

cod. 1.05.023

Il Kick Pro è un particolare cinturino in neoprene che, indossato sopra o sotto il ginocchio, o intorno alle caviglie, promuove la corretta tecnica di spinta. Limitando la distanza tra le gambe, limita l'ampiezza del movimento per attivare i muscoli esterni delle gambe e coinvolgere il core, con un conseguente aumento della velocità, grazie ad un calcio più efficiente.

The Kick Pro is a neoprene cuff worn above or below the knees, or around the ankles to promote proper kick technique. In limiting the distance between legs, the Kick Pro limits the range of motion to activate outer leg muscles and engage the core, resulting in a faster, more efficient kick.



**FINIS**

## POSTURE TRAINER

cod. 1.05.045

Il Posture Trainer aiuta la corretta posizione della testa e il giusto allineamento della colonna vertebrale, che sono la chiave per una tecnica di nuoto efficiente. Se correttamente indossato, il dispositivo è rilevabile solo se il nuotatore mantiene la postura ideale. Mantenendo la testa nella posizione corretta durante l'intero movimento natatorio, Posture Trainer corregge l'allineamento della colonna e dei fianchi, ottenendo la diminuzione della resistenza ed all'aumento della propulsione delle gambe. La versatilità di Posture Trainer consente l'utilizzo in tutti i quattro gli stili di nuoto e si adatta comodamente con o senza occhialini.

The Posture Trainer promotes correct head and spine alignment, which is key to an efficient swimming stroke. When properly attached, the device should be undetectable until the swimmer exceeds the recommended posture range. Keeping the head in the proper position throughout the entire swimming motion corrects spinal alignment, which elevates the hips, leading to a decrease in drag and an increase in kick propulsion. The Posture Trainer's versatility allows for use in all four swim strokes and fits comfortably with or without goggles.



**FINIS**

## SNORKELS

Respiratori frontali brevettati e progettati per i nuotatori. Possono essere indossati con tutti i tipi di occhialini da nuoto.

Used by the best coaches and the fastest athletes in the world. Swim at normal and much slower speeds with perfect stability and a full range of motion.



cod. 105.009.44  
SWIMMER'S  
YOUTH

cod. 105.009.48  
SWIMMER'S  
JUNIOR

cod. 105.009.50  
SWIMMER'S  
SNORKEL

cod. 105.009.112.50  
SWIMMER'S  
PINK

cod. 105.001  
FREESTYLE  
SNORKEL

**FINIS**

## INSTINCT SCULLING PADDLES

cod. 3.05.002.05 - M SIZE

cod. 3.05.002.06 - L SIZE

Lo speciale design di queste palette aumenta la sensibilità della braccia per migliorare la tecnica. Il design ergonomico aiuta ad insegnare ai nuotatori la corretta posizione del palmo della mano durante la spinta. La forma convessa permette la presa precoce e la posizione verticale dell'avambraccio, durante nelle prime fasi del movimento. Queste palette sono uno strumento versatile per tutti i quattro stili di nuoto e sono disponibili in due misure: medium e large.

The strapless design of the paddles heightens stroke awareness to improve technique. The ergonomically advanced design of the Instinct Sculling Paddles helps teach swimmers the correct palm positive hand position while sculling. The Instinct Sculling Paddles' convex design promotes an early catch and an early vertical forearm position in the sculling motion. The Instinct Sculling Paddles are a versatile tool for all four swim strokes and are available in two sizes: Medium & Large.



**FINIS**

## FINGER PADDLES

cod. SWE 0008 size L



Palette dita per il training. Ideale per mantenere sensibilità della mano e per l'allenamento a rana e farfalla.

The streamline design allowing the legs to stay more active throughout the workout.



## POWER PADDLES

cod. SWE 0016 size S

cod. SWE 0017 size M

cod. SWE 0018 size L

Paletta anatomica con fori, ideale per il training del nuotatore di livello.

Anatomically designed paddles with holes, ideal for training.

Dimensioni  
Dimension

cod. SWE 0016 15,5 x 14,5 cm  
cod. SWE 0017 19 x 18,5 cm  
cod. SWE 0018 22 x 20,5 cm

## COMFORT PADDLES

cod. SWE 0011 size M

cod. SWE 0012 size L



Paletta bicolore con bordatura gommata antinfortunio e sagomatura ideale per alloggiamento mano.

Two-colour paddle with rubber safety border and ideal shape for hand placement.

Dimensioni  
Dimension

cod. SWE 0011 19 x 13 cm  
cod. SWE 0012 22,2 x 15,2 cm

Materiale  
Material

PPT + TPR

Elastici  
Adjust. straps

Silicone

## FOREARM FULCRUM

cod. 1.05.028.50 mod. SENIOR

cod. 1.05.028.48 mod. JUNIOR



Migliora la tecnica della bracciata, allineando mano, polso e gomito.

Improve your stroke efficiency and technique. Creates an ideal elbow-wrist angle for most efficient application of propulsive force.

## BOLSTER PADDLES

cod. 1.05.026

Disegnata per facilitare la corretta posizione polso-gomito. Aiuta ad eseguire la spinta più efficace nella fase finale della bracciata, potenziando l'effetto propulsorio.

The bolster forces the swimmer to develop a forearm dominant stroke and keeps the elbow up and in position to provide more propulsion.



## AGILITY PADDLES

cod. 1.051.45.04 size S

cod. 1.051.45.05 size M

cod. 1.051.45.06 size L



L'innovativo design ergonomico di Agility Paddles aiuta a insegnare ai nuotatori la corretta posizione della mano.

The ergonomically advanced design of the Agility Paddles helps teach swimmers the correct palm positive hand position.



## FREESTYLER PADDLES

cod. 1.05.020.50 mod. SENIOR

cod. 1.05.006.48 mod. JUNIOR



Paletta appositamente progettata per migliorare la tecnica della bracciata nello stile libero, guidando il braccio verso un miglior allungo e una presa più efficace.

The hydrodynamic shape promotes a clean entry and the planing action that occurs on the front end of the stroke.



## FINS

### EDGE FINS

cod. 2.35.050

Pinne allenamento di velocità, progettato per fare tutto. Sono state progettate dal FINIS Stroke Lab per ottimizzare l'allenamento senza interrompere la propulsione della gambata o compromettere il comfort. La combinazione di Silicone 100% con la tecnologia brevettata Smart Fin™ rendono efficace l'utilizzo ad alta velocità, allenando la resistenza cardiovascolare e attivando i muscoli coinvolti nella gambata.

The Edge fins are the ultimate speed training fins, engineered to do it all. Through extensive testing at the FINIS Stroke Lab, the Edge fins were designed to optimize training without interrupting a natural kick cycle or compromising on comfort. The combination of 100% silicone and trademarked Smart Fin™ Technology reinforces a proper kick at high speeds, builds cardiovascular endurance and activates key muscle groups for a propulsive up-kick.



Codice Code	Taglia Size	Euro
<b>01</b>	SMALL	375 - 40
<b>05</b>	MEDIUM	40 - 42
<b>06</b>	LARGE	42,5 - 45
<b>07</b>	X LARGE	45 - 48

## ZOOMERS® GOLD

### SHORT BLADE TRAINING FINS

cod. 2.35.003

Size	US Male	US Female	Euro
<b>C (12)</b>	35 - 5	45 - 6	35 - 36
<b>D (13)</b>	55 - 7	65 - 8	37 - 39
<b>E (14)</b>	75 - 85	85 - 95	40 - 42
<b>F (15)</b>	9 - 10	10 - 11	43 - 44
<b>G (16)</b>	10 - 115	11 - 125	44 - 45
<b>H (17)</b>	115 - 13	125 - 14	46 - 48



Pinnette corte per una migliore spinta propulsiva.  
Short blade swim fin that promotes a smaller, faster, more propulsive kick.

## Z2 GOLD ZOOMERS®

### SHORT BLADE SWIM FINS

cod. 2.35.004 - A e B - JUNIOR

cod. 2.35.004 - da C a I - SENIOR

Size	Code	Euro
<b>A</b>	68	33 - 34
<b>B</b>	69	35 - 36
<b>C</b>	70	36 - 37
<b>D</b>	71	38 - 39
<b>E</b>	72	40 - 41
<b>F</b>	73	41 - 43
<b>G</b>	74	44 - 45
<b>H</b>	75	45 - 46
<b>I</b>	76	46 - 48



Pinnette dal design particolare che migliora l'azione delle gambe durante la nuotata.  
The streamline design allowing the legs to stay more active throughout the workout, diving block or ladder.

## FINS

### EXTRA FINS

cod. SWE 0015

Size	JUNIOR
<b>31/32</b>	12,5/13,5
<b>33/33</b>	1/2
<b>35/36</b>	2,5/3,5
<b>37/38</b>	4/5
<b>39/40</b>	5,5/6,5
<b>41/42</b>	7/8
<b>43/44</b>	8,5/9,5
<b>45/46</b>	10/11



Pinnette corte molto flessibili, ideali per il nuotatore, per la riabilitazione e per il fitness acquatico.  
Short and very flexible fins, ideal for swimming, rehabilitation and aquatic fitness.

## RONDINELLA

cod. CRS 0001 - JUNIOR

cod. CRS 0002 - SENIOR

JUNIOR	
<b>29/30</b>	1/2
<b>31/32</b>	2,5/3,5
SENIOR	
<b>33/34</b>	1/2
<b>35/36</b>	2,5/3,5
<b>37/38</b>	4/5
<b>39/40</b>	5,5/6,5
<b>41/42</b>	7/8
<b>43/44</b>	8,5/9,5
<b>45/46</b>	10/11
<b>47/48</b>	11,5/12,5



La pala: un vero prolungamento del piede che migliora la spinta del 30%.  
The blade: a considerably long extension that improves thrust by 30%.



## ELECTRONICS

### DUO UNDERWATER

cod. 1.30.058.121 - DARK GRAY/MINT  
cod. 1.30.058.244 - BLACK/ACID GREEN



Lettoce MP3 progettato per i nuotatori. Offre la massima qualità dell'audio senza l'utilizzo di auricolari: i due trasmettitori dal design elegante sfruttano il sistema di conduzione ossea dell'audio, che arriva cristallino dagli zigomi all'orecchio interno. Il sistema a clip mantiene fermi i trasmettitori sulle cinghie degli occhialini per una calzata confortevole e snella. Un'interfaccia semplificata offre quattro pulsanti per navigare facilmente tra i brani, podcast, audiolibri e altri file audio supportati. Il Duo supporta file MP3 non protetti. Il cavo USB in dotazione consente il trasferimento di dati universali e di ricarica. Il dispositivo offre 4GB di memoria flash e una batteria ricaricabile agli ioni, con durata fino a 7 ore.

The Duo is an MP3 player designed for swimmers that offers the highest quality sound without the use of ear buds. The Duo utilizes a sleek, two-piece design and Bone Conduction audio transmission to deliver crystal clear audio through cheekbones to the inner ear. An integrated clip design secures the Duo to goggle straps to rest on the cheekbones for a comfortable and streamlined fit. A simplified interface offers four buttons to easily navigate between songs, podcasts, audiobooks and other supported audio files. The Duo supports unprotected MP3 and WMA files. The included auxiliary USB cable allows for universal data transfers and charging. The device offers 4GB of flash memory and a Lithium-Ion rechargeable battery life of up to 7 hours.

### STOP WATCH

cod. 1.30.040 - 3 x 300 MEMO  
cod. 1.30.032 - 3 x 100 MEMO

Cronometro digitale con 300 o 100 memorie.  
300 or 100 Memory Stopwatch.



### TEMPO TRAINER PRO

cod. 1.05.120

Dispositivo elettronico che, emettendo un segnale acustico, aiuta a sviluppare una bracciata regolare, per un migliore allenamento del ritmo di gara.

Transmits an audible beep to help develop consistency of stroke and cycle rates. A user friendly waterproof metronome which scrolls in hundredths of a second.







AQUAPOOL  
LINE



## BOXES AND SHELVES

cod. AFO 0133 - MEDIUM BOX

cod. AFO 0134 - MAXI BOX

cod. AFO 0148 - SHELF RACK

cod. AFO 0137 - SHELVES 3

cod. AFO 0138 - RACK

cod. AFO 0136 - BENCH SMALL

cod. AFO 0135 - BENCH BIG

Contenitori, scaffali modulari e panca, in pvc, utili per stoccaggio attrezzatura. Forniti smontati e con manuale per l'assemblaggio. Ruote con blocco.

Modular pvc box, shelves and bench useful for pool equipment storage. Disassembled, with manual assembly. Wheels with brake.



### MEDIUM BOX

cod. AFO 0133

Dimensioni

Dimension

75 x 60 x h120 cm

Colore

Colour

bianco/blu

white/blue

Ruote

Wheels

4



### MAXI BOX

cod. AFO 0134

Dimensioni

Dimension

100 x 70 x h110 cm

Colore

Colour

bianco/blu

white/blue

Ruote

Wheels

4



### SHELF RACK

cod. AFO 0148

Dimensioni

Dimension

100 x 40 x h192,5 cm

Colore

Colour

bianco/blu

white/blue



### SHELVES 3

cod. AFO 0137

Dimensioni

Dimension

126 x 80 x h187 cm

Colore

Colour

bianco/blu

white/blue

Ruote

Wheels

4



### RACK

cod. AFO 0138

Dimensioni

Dimension

235 x 60 x h200 cm

Colore

Colour

bianco/blu

white/blue



### BENCH

cod. AFO 0136 SMALL

cod. AFO 0135 BIG

cod. AFO 0136  
SMALL

100 x 42 x h45 cm

bianco/verde  
white/green

cod. AFO 0135  
BIG

200 x 42 x h50 cm

bianco/blu  
white/blue



## EASY LOOK PACE CLOCK

cod. AFO 0509 24 Volt 50 Hz  
cod. AFO 0510 220 Volt 50 Hz

Contasecondi in forex e alluminio, con lancette colorate.  
Possibilità di ordinare la versione ad alimentazione 24 Volt 50 Hz (AFO 0509) oppure a 220 Volt 50 Hz (AFO 0510).

Pace clock made in forex. Available 24 Volt 50 Hz (AFO 0509) or 220 Volt 50 Hz (AFO 0510).



<b>cod. AFO 0509</b>	97 x 97 x 10 cm	24 Volt 50 Hz
<b>cod. AFO 0510</b>	97 x 97 x 10 cm	220 Volt 50 Hz

## Ricambi | Spare parts

**AFO 0506**  
motorino 24 Volt 50 HZ  
electric motor 24 V 50Hz

**AFO 0508**  
motorino 220 Volt 50 HZ  
electric motor 220 V 50Hz

**AFO 0507**  
trasformatore 220/24 Volt 50 HZ  
transformer 220/24 Volt 50 HZ

## MODULAR BOX

cod. AFO 0127

Contenitori modulari per Noodles.  
Completo di ruote.

Modular box for Noodles.  
Supplied with wheels.

**cod. AFO 0127** | 80 x 40 x h126 cm



## NET BOX

cod. AFO 0130

Carrello in pvc provvisto di ruote per agevolare lo spostamento.

Basket/trolley for equipment, with wheels for easy handling.

**cod. AFO 0130** | 100 x 60 x h95 cm



## BOX

cod. AFO 0110 mod. Maxi  
cod. AFO 0111 mod. Mini

Contenitore per attrezzatura, provvisto di ruote per agevolare lo spostamento. Ruote senza blocco.

Container for equipment, with practical wheels for easy handling.



**cod. AFO 0201**  
Ruote senza blocco.  
Wheels without brake.

<b>cod. AFO 0110 - MAXI BOX</b>	blu blue	120 x 80 x h100 cm	polypropylene copolymer
<b>cod. AFO 0111 - MINI BOX</b>	grigio grey	100 x 70 x h80 cm	polypropylene copolymer
<b>cod. AFO 0200 - COVER MAXI</b>	grigio grey	121,5 x 81 cm	polypropylene copolymer
<b>cod. AFO 0210 - COVER MINI</b>	grigio grey	102 x 72 cm	polypropylene copolymer



## M.A.P. Modular Aquatic Platform

### PEDANE IN INOX STAINLESS STEEL PLATFORMS

Pedana modulare in inox e PVC. Compatibile con qualsiasi tipo di vasca, è stabile e sicura, quindi ideale per svolgere esercitazioni con attrezzature pesanti e/o attività molto dinamiche con popolazione adulta. Ogni modulo può avere altezza variabile (min. 200 mm).

Modular platform: stainless steel and PVC. Useful with any type of swimming pool, is stable and safe, so ideal for performing exercises with aquabikes or other big equipment or dynamic activities with adults. Each platform is with variable height (min. 200 mm).

**Consegna: 40 giorni lavorativi.**  
**Delivery: 40 working days.**



Materiale: inox AISI 316L + plastica ABS  
Material: 316 L stainless steel + ABS plastic

Su richiesta | On request

**cod. AFA RGEN A03**  
ventosa blu  
blue suction cap



Le pedane vengono fornite con ventose trasparenti. Su richiesta, è possibile fornirle con ventose blu. The platforms are supplied with transparent suction caps. The blue suction caps shown on the picture are available on request.

Dettagli | Details



Codice  
Code

**cod. AFO PEA 300 - 2**  
**cod. AFO PEA 400 - 2**  
**cod. AFO PEA 500 - 2**  
**cod. AFO PEA 600 - 2**  
**cod. AFO PEA 700 - 2**  
**cod. AFO PEA 800 - 2**

Dimensioni  
Dimension

200 x 100 x h30 cm  
200 x 100 x h40 cm  
200 x 100 x h50 cm  
200 x 100 x h60 cm  
200 x 100 x h70 cm  
200 x 100 x h80 cm

Codice  
Code

**cod. AFO PEA 200**  
**cod. AFO PEA 300**  
**cod. AFO PEA 400**  
**cod. AFO PEA 500**  
**cod. AFO PEA 600**  
**cod. AFO PEA 700**  
**cod. AFO PEA 800**

Dimensioni  
Dimension

140 x 100 x h20 cm  
140 x 100 x h30 cm  
140 x 100 x h40 cm  
140 x 100 x h50 cm  
140 x 100 x h60 cm  
140 x 100 x h70 cm  
140 x 100 x h80 cm

### PEDANE IN PVC PVC PLATFORMS

Pedana modulare in pvc, con fissaggi in inox. Compatibile con qualsiasi tipo di vasca, è adatta allo svolgimento di attività aquafitness e ludico/didattiche. Ogni modulo è 100 x 100 cm, con altezza variabile (min. 200 mm). Su richiesta è possibile realizzare piattaforme con corrimano, destinate a categorie di bambini under 4 o a chi in acqua deve seguire protocolli riabilitativi in piena sicurezza (vedi pag. 14).

Modular PVC platform, with stainless steel elements. Useful with any type of swimming pool, is suitable for fun / learning activities with children. Each platform is 100 x 100 cm, with variable height (min. 200 mm). On request it is possible to make teaching platforms with handrails, suitable for under 4 children or rehabilitation protocols.

**Consegna: 20 - 30 giorni lavorativi.**  
**Delivery: 20 - 30 working days.**



Codice  
Code

**cod. AFO PEM 200**  
**cod. AFO PEM 250**  
**cod. AFO PEM 300**  
**cod. AFO PEM 400**  
**cod. AFO PEM 500**  
**cod. AFO PEM 600**

Dimensioni  
Dimension

100 x 100 x h20 cm  
100 x 100 x h25 cm  
100 x 100 x h30 cm  
100 x 100 x h40 cm  
100 x 100 x h50 cm  
100 x 100 x h60 cm

## BLOCCHI PARTENZA

### BLOCCO PARTENZA ALTO

#### HIGH STARTING BLOCK

cod. AFO 0030

#### Soluzione ideale per le piscine con lo sfioro su ogni lato (prive di muretti di testata).

Completo di maniglione di partenza a dorso regolabile, piattaforme in vetroresina antiscivolo, viteria inox e numeri adesivi.

La verifica statica, realizzata nel rispetto delle norme nazionali, dimostra che la struttura è ampiamente verificata per un carico di 500 Kg. distribuiti sulla sommità rimanendo anche un discreto margine di sicurezza. Rispetta le norme FINA (FR.2.7).



#### The ideal solution for deck-level swimming pools (without a headwall).

Supplied with adjustable backstroke starting handle, anti-slip stainless steel platforms, stainless steel screw fittings and adhesive numbers.

The static tests, performed in compliance with national regulations, demonstrate that the structure has been extensively proven to support a weight of 500 Kg. on top, with an additional reasonable margin of safety. Manufactured in compliance with FINA facility rules (FR.2.7).

Altezza High	70 cm
Materiale Material	acciaio inox AISI 316 elettrolucidato electropolished AISI316 stainless steel

### BLOCCO PARTENZA BASSO

#### LOW STARTING BLOCK

cod. AFO 0031

#### Adatto alle piscine realizzate con i muretti di testata.

Completo di maniglione di partenza a dorso regolabile, piattaforma da 50x50 cm in vetroresina antiscivolo, viteria inox e numeri adesivi. Rispetta le norme FINA (FR.2.7).

#### Ideal for swimming pools with masonry headwalls.

Supplied with adjustable backstroke starting handle, anti-slip 50x50 cm stainless steel platforms, stainless steel screw fittings and adhesive numbers. Manufactured in compliance with FINA facility rules (FR.2.7).



Altezza High	40 cm
Materiale Material	acciaio inox AISI 316 elettrolucidato electropolished AISI316 stainless steel

## BOARD GUARD

cod. AFO 0300

Si consiglia l'utilizzo del Parabordo nelle fasi di inserimento ed estrazione dell'attrezzo dalla vasca, per evitare sbeccature del gres o tagli del telo in pvc.

Use of the Fender is recommended when inserting and extracting the equipment from the pool, to prevent chipping of tile and damages of PVC liner.



Dimensioni Dimension	90 x 30 x 30 cm
-------------------------	-----------------

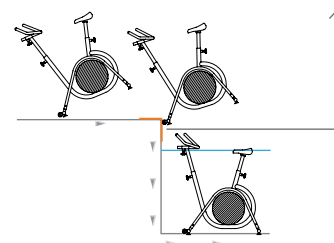

## BANDIERINE VASCA

cod. AFO 0021

Bandierine Aquatix in PVC leggero e resistente.

Aquatix PVC flags.

Lunghezza Length	20 mt 27 bandierine 20 x 20 cm 27 flags 20 x 20 cm
---------------------	--



## LANES

### GOLD LANE

Corsia con cavo in acciaio. A norma FINA, è adatta anche per competizioni. Fornita senza tenditore e mollone. Colorazione standard in pronta consegna.



Lane line with plasticized steel cable. Complies with FINA regulations. Also suitable for competitions and training. Supplied without tensioner and spring. Standard colours on prompt delivery.



cod. AFO 0006  
cod. AFO 0008

25 m - Ø 12 cm  
50 m - Ø 12 cm

Colori disponibili  
Available colours



## WELLNESS LANE

cod. AFO 0013

**Misure a preventivo.** Corsia wellness con moduli in espanso a forma di fiore. Resistente e antinfortunio in caso di urto accidentale. Design e forma originali. Montate su cavo in nylon per garantire praticità di spostamento.

**Sizes on request.** Wellness lane in rigid expanded polyurethane foam flower-shaped. Resistant and accident prevention in case of accidental impact. Original design and shape. Supplied with nylon cord to ensure easily movement.

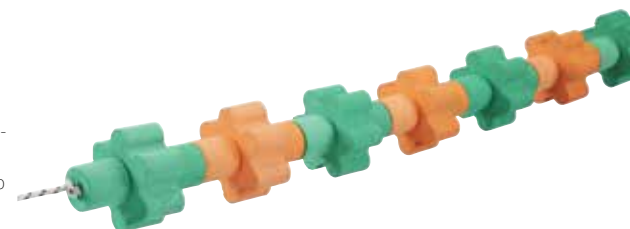

cod. AFO 0013

Ø 9 cm

Colore standard\*  
Standard colour\*



\* Possibilità di ordinare altri colori: minimo 20 mt

\* It is possible to order other colours: minimum 20 mt

## PLATINUM LANE

Corsia con cavo in acciaio, speciale trattamento anti-acido e anti-UVA. A norma FINA, è adatta anche per competizioni internazionali. Fornita senza tenditore e mollone. Colorazione standard in pronta consegna.

Lane line with plasticized steel cable, special anti-acid and anti-UVA treatment. Complies with FINA regulations. Also suitable for international and high-level competitions. Supplied without tensioner and spring. Standard colours on prompt delivery.



cod. AFO 0009  
cod. AFO 0011

25 m - Ø 15 cm  
50 m - Ø 15 cm

Colori disponibili  
Available colours



## TENDITORE DOPPIO FILETTO GR 30

cod. AFO 0105



Tenditore a doppio filetto per modelli: GOLD, PLATINUM e EASY.

Double threaded tensioner for: GOLD, PLATINUM and EASY lanes.

## MOLLA INOX

cod. AFO 0102



Molla in inox per modelli: GOLD, PLATINUM e EASY.

Stainless steel tension spring for: GOLD, PLATINUM and EASY lanes.

## TENDITORE CRICCHETTO GR 10

cod. AFO 0101



Tenditore a cricchetto per modelli: GOLD, PLATINUM e EASY.

Ratchet tensioner for: GOLD, PLATINUM and EASY lanes.

## EASY LANE

Corsia per allenamento, ideale anche per piscine didattiche, grazie alle dimensioni ridotte. Realizzata in PP di prima qualità. Fornita senza tenditore e mollone. Colorazione standard in pronta consegna.

Ideal for trainings. Made of top quality PP. Supplied without tensioner and spring. Standard colours on prompt delivery.



cod. AFO 0020

25 m - Ø 8,5 cm

Colori disponibili  
Available colours

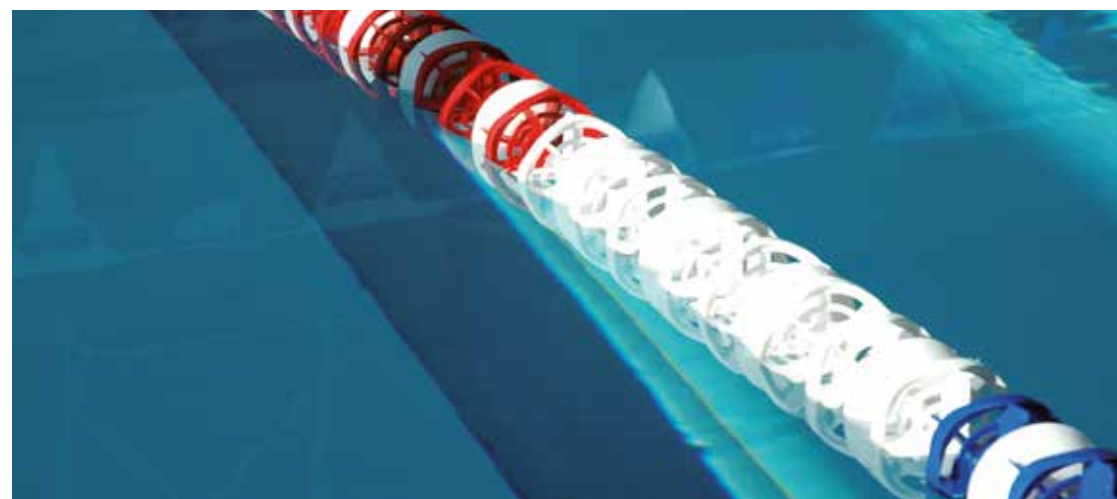



AQUATIX NASCE NEL 2006, GRAZIE AD IDEE E COMPETENZE DI PERSONE  
CON OLTRE 30 ANNI DI ESPERIENZA TECNICA, SPORTIVA, CULTURALE  
ED IMPRENDITORIALE NEL SETTORE PISCINA.

AQUATIX WAS CREATED IN 2006 BY THE WILL OF YOUNG ENTREPRENEURS,  
WILLING AND ABLE TO ENTER INTO THE WATERWORLD WITH NEWS  
AND DETERMINATION.

## Vision

Acqua come stile di vita e contesto imprescindibile per ogni individuo (motoriamente attivo o inattivo): benessere, salute, prevenzione e divertimento possono essere veicolati dall'acqua, attraverso la realizzazione e l'utilizzo di attrezzi, ausili, giochi che facilitino le percezioni e le sensazioni che l'acquaticità può regalare, percorrendo i tempi, innovando e promuovendo una ricerca costante, senza trascurare l'oggi, fatto di tradizione e certezze.

To be the best interpreters of Wellness conveyed to water through the creation of tools and aids that facilitate the perceptions and feelings that can give aquatic world, going through the time with innovation and being at the forefront, without leaving aside the today tradition and certainty.

Interpretare l'Acqua come fonte di salute e benessere autentici, perseguibili grazie ad attrezzature o soluzioni studiate e realizzate con rigore etico, scientifico, professionale e massima sensibilità per design, sicurezza e qualità (EAA e il centro R&D di Aquatix), partendo dall'analisi dei bisogni di ogni persona e armonizzando ogni scelta con le esigenze pratico-strategico-imprenditoriali di chi crede nell'acqua come ambiente ideale. Acqua come elemento declinabile in tutte le sue interpretazioni volte a garantire emozioni ed esperienze positive per l'individuo, facilitate da attrezzature uniche al mondo. Acqua come idea universale di benessere, salute, prevenzione, movimento, divertimento e relax, proiettata su scala mondiale.

## Mission

To interpret water as a source of true wellness, enhancing the benefits through equipment designed and built according to this priority, whereas conscious and unconscious needs of consumer and reconciling the needs of practical and strategic-business trade, the latter not only understood as pool, but also as a spa, entertainment and recreation center, no longer limited to the national context, but above all outside our borders, projecting also to medium-high pool of housing. The same time be aware of the role of a guide that enhances the equipment to enhance the properties of water by the appropriated and correct use of it.

Le immagini e i testi di questo catalogo si intendono a titolo indicativo.  
Aquatix si riserva di apportare modifiche ai prodotti in qualsiasi momento e senza preavviso.  
The pictures and descriptions in this catalogue are provided solely as a guide.  
Aquatix reserves the right to make any change to the products at any time and without notice.



**aqquatiX**<sup>®</sup>  
equipment for very aqquatiX people

**AQQUATIX SRL**  
Limena (Padova)  
ITALY  
T. +39 049 738 11 50

[www.aqquatiX.com](http://www.aqquatiX.com)  
Italy: [info@aqquatiX.com](mailto:info@aqquatiX.com)  
Export: [export@aqquatiX.com](mailto:export@aqquatiX.com)

Training by EAA  
[www.euroaquatic.it](http://www.euroaquatic.it)